

# Business Requirements Document

For

## Meter Read Submission and Processing and Settlement Arrangements for All Gas Meter Points

### Xoserve Project Nexus

Author (for this version):	Xoserve
Version:	3.1
Filename:	
Date:	20/09/2013

- michele.downes 23/9/13 10:39  
Deleted: 0
- michele.downes 23/9/13 10:39  
Deleted: 07
- michele.downes 23/9/13 10:39  
Deleted: 5

*This document contains confidential or privileged information; it should not be copied or disclosed to any third party without the express permission of Xoserve Ltd. All rights reserved.*

Copyright © 2012 Xoserve Ltd

- michele.downes 23/9/13 10:39  
Deleted: 0
- Mike Berrisford 23/9/13 13:30  
Deleted: 23/09/2013
- Mike Berrisford 23/9/13 13:30  
Deleted: 08/05/2013

**Table of Contents:**

1. Introduction	3
2. Executive Summary	4
3. Design Considerations	9
4. Business Process Maps	12
5. Business Requirements Definition	20
6. Non-Functional Business Requirements	37
7. Appendices	38
8. Glossary	39
9. Document Control	41

michele.downes 23/9/13 10:39  
**Deleted:** 0

Mike Berrisford 23/9/13 13:30  
**Deleted:** 23/09/2013

Mike Berrisford 23/9/13 13:30  
**Deleted:** 08/05/2013

## 1. Introduction

### 1.1 Document Purpose

The purpose of this document is to ensure that the business requirements associated with the referenced change have been accurately captured, and to clearly specify these requirements to the Project Nexus UNC Workgroup (PN UNC). Adequate information should be provided to enable the industry to approve the documented requirements for Cost Benefit Analysis at a later stage.

The contents refer to the business scope of the change, and provide descriptions of the business requirements and the relevant 'As Is' and 'To Be' process maps.

This document is an amalgamation of two documents describing business requirements for the AMR Workgroup and the Settlement Workgroup. The document contains tracked versions since the last published version. This version and any future versions will contain business requirements for all gas meter points (see section 2.6 for clarification of the scope).

### 1.2 Related Documents

Documents held on the Joint Office website under Project Nexus, in particular:

- AMR Workgroup meetings
- Settlement Workgroup meetings
- PN UNC Workgroups

<http://www.gasgovernance.co.uk/nexus>

michele.downes 23/9/13 10:39
<b>Deleted:</b> 0
Mike Berrisford 23/9/13 13:30
<b>Deleted:</b> 23/09/2013
Mike Berrisford 23/9/13 13:30
<b>Deleted:</b> 08/05/2013

## 2. Executive Summary

### 2.1 Introduction to the Change

This document defines the processes for the submission and processing of Meter Readings and Settlement arrangements for all gas meter points.

The document has been based on presentations and discussions at the Project Nexus AMR Workgroup, Settlement and PN UNC Workgroup and considering the high level principles agreed at the Allocation Workgroup.

### 2.2 Change Drivers and Business Goals

#### 2.2.1 Drivers

The drivers detailed below are those identified by the Settlement Workgroup and the AMR Workgroup specifically for the submission and processing of meter readings and settlement arrangements in the gas industry.

1. To reduce the difference between gas nomination, actual consumption and gas allocation.
2. Reduce the changes in forecasting & allocations between D-5 to D+5.
3. Improve existing allocation processes
4. Implement a fairer smearing mechanism
5. Visibility of the value of un-allocated energy
6. Provide services to enable Shippers to submit more reads for utilising in downstream processes
7. Appropriate incentives & obligations on parties for both remotely read metered & dumb metered sites
8. To utilise the reads obtained from remotely read meters to improve energy allocation
9. Improve the existing meter reading processes and remove the constraints relating to the current system
10. Develop solutions appropriate for 'smart' meters
11. Improve the accuracy of energy allocation
12. Improve validation routines to reduce the number of exceptions created at the end of the process e.g. charge creation

#### 2.2.2 Goals

- In the long term Shippers/Suppliers may choose to have all sites utilising actual daily reads for energy allocation (after the day), energy balancing and settlement processes, dependent on a robust cost benefit analysis.
  - However, this regime is only achievable in a fully 'remote metered' world (or when 'critical mass' of remote meters has been achieved).
  - The requirements and rules described in this document are therefore the arrangements for all directly connected sites during the Smart meter roll-out. These arrangements provide the platform for progression to a daily settlement regime for all gas meter points at a point in the future.
- The goal for the Workgroup is therefore to develop a robust regime for meter reading processes and settlement arrangements and a potential 'stepping-stone' towards the ultimate goal of daily settlement based on daily reads at a point in the future.

### 2.3 Change Background

michele.downes 23/9/13 10:39

Deleted: 0

Mike Berrisford 23/9/13 13:30

Deleted: 23/09/2013

Mike Berrisford 23/9/13 13:30

Deleted: 08/05/2013

The changes have been identified as a result of Xoserve's Project Nexus consultation for the replacement of UKLink systems and following DECC's consultation on Smart metering and Supplier licence obligation for the installation of advanced meters.

## 2.4 Process Issues

At the AMR Workgroup meeting on the 31<sup>st</sup> March 2010, attendees identified issues and constraints with the existing meter reading processes. The discussions were based on the processes designed for the Daily Metered Elective (DME) regime. The following issues were raised:

1. Calculation & provision of estimated reads
2. Deadline for receipt of daily reads
3. Replacement of reads (actual or estimated)
4. Limits on volumes
5. Backstop where no reading provided (estimated or actual)
6. Transfer reading - Close out of an estimated reading where an actual is available

The following issues were identified in the Settlement Workgroup during March 2011;

1. Difference in values between gas nominations, actual consumption and allocations
2. Profiling and Scaling Factors are not appropriate
3. Estimation methodology
4. Unfair smearing mechanism
5. Current regime does not reflect changes in site consumption quickly

The following issues were raised during the Project Nexus Consultation (taken from the Initial Requirements Register):

IRR Ref.	Issue
4.1	Removal of volumes quotas and the ability to support half-hourly reads
4.2	Use of a data aggregator to reduce volume of data received by Xoserve
4.3	Additional and more accurate energy consumption information
4.4	Allow more frequent reads from AMR to feature in daily reconciliation
4.5	All energy consumption data should be used to ensure that costs are targeted at those that incur them on the system
4.6	Daily energy allocations for a large part, if not all, of the metering points
7.1	Submit volumes as an alternative to meter readings
10.7	Use energy consumption data to develop an additional SSP profile for I&C sites
10.8	Shipper demand allocation data split out by market sector (SSP & LSP) and by LDZ on a daily basis
10.10	Create a new EUC band for Small Supply Points
10.11	Review of the process of Winter Annual Ratio calculation, and the subsequent allocation of EUC and thus load profile
13.9	Meter read window preferably abolished or at least extended significantly from its current 15 days

## 2.5 Benefits

michele.downes 23/9/13 10:39

**Deleted:** 0

Mike Berrisford 23/9/13 13:30

**Deleted:** 23/09/2013

Mike Berrisford 23/9/13 13:30

**Deleted:** 08/05/2013

The benefits will need to be aligned with the Transporters relevant objectives.

1. Improve accuracy of the energy allocation
2. More appropriate way for allocating energy in a 'smart' world
3. Utilise the reads from remotely reads meters
4. Industry will have a better understanding of the value of unallocated energy
5. Utilising up-to-date information
6. More reflective of actual consumption
7. Improve the accuracy of meter reads loaded and used for downstream processes

## 2.6 Scope

### In Scope

Function:

1. Receipt and processing of meter readings
2. After the day gas allocations
3. Share of un-allocated energy
4. Estimation methodology for allocation purposes
5. Estimation methodology for missing reads
6. Read validation
7. Incentives & obligations

Market Sectors:

1. All remotely read metered (Smart & AMR) sites
2. All dumb metered sites
3. DM CSEPs
4. NDM CSEPs (aspiration for all iGT sites to be treated the same as directly connected sites)
5. NTS & Telemetered sites

### Out of Scope

Function:

1. Reconciliation processes
2. Shrinkage calculation
3. AQ processes
4. Transportation Invoicing

Market Sectors:

1. Receipt and processing of meter reads for NTS & LDZ Telemetered sites as validated energy is received rather than reads for these sites

## 2.7 UNC & Licence Impacts

- Uniform Network Code Validation Rules
- UNC Section G
  - 1.5 Daily Read Metering
  - 2. Supply Point Registration
- UNC Section H
- UNC Section M
  - 1.5 Validation
  - 3. Meter Reading: Non Daily Read Supply Meters
  - 4. Daily Read Supply Meters
  - 5. Provision of Daily Read Meter Readings to Users
  - 6. Provision of User Daily Read Meter Readings to Transporters

## 2.8 UNC Process Impacts

michele.downes 23/9/13 10:39

**Deleted:** 0

Mike Berrisford 23/9/13 13:30

**Deleted:** 23/09/2013

Mike Berrisford 23/9/13 13:30

**Deleted:** 08/05/2013

A high level assessment has been carried out on the following processes;

- Demand Estimation is likely to be impacted by the processes described in this document although a larger population of sites with the ability to submit daily reads may improve the size of the sample available for the Demand Estimation processes.

A full process assessment was not conducted. Other processes will be assessed as and when potential interactions are identified.

### 2.9 Interaction with Project Nexus High Level Principles

The business rules defined within this document are not in alignment with the preferred option for Allocation as described in the Allocation Principles report, which envisages settlement based on daily reads for all 21m gas customers, whether Smart or AMR. Products 3 and 4 are not consistent with this Principle.

The requirement for regular daily estimation of site consumption, particularly those where only periodic readings are received, will probably necessitate the continuing use of an AQ, which is not in alignment with the preferred outcome of the AQ Principles workgroup of a 'No AQ' regime.

### 2.10 Summary of the 4 Meter Reading and Settlement Products

The following table is a summary of the four products for future meter reading submission and processing and Settlement regime which were agreed at the AMR Workgroup and Settlement Workgroup. The detailed business requirements are documented under section 5.

Note:

- All these products will be available in the future solution; they are not alternative solutions.
- For Product 1; Daily Metered Time Critical sites; these are Daily Metered Supply Points as defined in UNC (G1.5) or; where the GT specifies the Supply Point is DM Mandatory for network operation activities or the Shipper nominates the site as 'critical' due to the impacts on Allocation and Energy Balancing.
- All 'days' specified within this document refer to calendar days except where stated 'business days'.

michele.downes 23/9/13 10:39

**Deleted:** 0

Mike Berrisford 23/9/13 13:30

**Deleted:** 23/09/2013

Mike Berrisford 23/9/13 13:30

**Deleted:** 08/05/2013

**Summary of the 4 Meter Reading and Settlement Processes**

Product – Description	Day Ahead Gas Nomination	Process for initial Allocation	Process for Energy Balancing close-out	Read Submission Timescales	Type of Read Submission	Read Submission Performance Target	Read Submission Deadline	Maximum Read Submission	Must Read Trigger	Check Read Obligation
1 – Daily Metered Time Critical Readings	Shipper nominates (singly or in aggregations)	Uses daily read	Uses daily read	By 10am on GFD+1	All reads daily on GFD+1	97.5% daily target	5 calendar days following the read date	N/A	N/A	12 months
2 - Daily Metered not Time Critical Readings	Shipper nominates (singly or in aggregations)	Transporter estimate unless read received before 10.00 am	Uses daily read	By end of GFD+1 (05.59 am)	All reads daily by end of GFD+1	97.5% daily target	5 calendar days following the read date	N/A	4 consecutive months	12 months
3 – Batched Daily Readings	GT Nominates	Allocation processes	Allocation processes	Daily Reads in batches	All reads in batches to an agreed frequency	90% monthly target	Month + 10 calendar days	Daily	4 consecutive months	12 months
4 – Periodic Readings	GT Nominates	Allocation processes	Allocation processes	Periodic	Periodic reads to an agreed frequency	Monthly MRF: 90% per calendar month SSP Annual: 70% in 12 month period LSP Annual: 90% in 12 month period	25 calendar days following the read date	Monthly MRF: 7 days Larger Annual MRF 14 days: Smaller Annual MRF: 25 days	Monthly MRF: 4 consecutive months Annual MRF: 24 consecutive months	12 months for monthly MRF, 24 months for annual MRF

michele.downes 23/9/13 10:40  
**Deleted:** 0  
 Mike Berrisford 23/9/13 13:30  
**Deleted:** 23/09/2013  
 Mike Berrisford 23/9/13 13:30  
**Deleted:** 08/05/2013



### **3. Design Considerations**

#### **3.1 Implementation Timescales:**

- Implementation of the developed solution will be confirmed once all requirements are captured following the Project Nexus Requirements Definition Phase.

#### **3.2 Dependencies:**

1. Approval of the requirements by PN UNC.
2. Approval by Ofgem following the appropriate UNC Modification process.

#### **3.3 Risk & Issues:**

1. Any incorrect reads loaded into the system for Products 1 & 2 will have an impact on the existing Allocation regime. This is as per the current process however, with the potential increase of sites moving to a daily metered regime the effects and impacts may be far greater on the energy allocated to non daily read sites.
2. A concern was raised by workgroup members regarding the D-7 estimate for Product 2 sites (Section 5.6.2). It was felt that the D-7 estimate may not be appropriate for smaller/weather sensitive I&C sites as it does not take into account any fluctuations in the weather.
3. Not all Shippers/Suppliers attend the Workgroups or are represented therefore there may be opposition to any potential Modifications raised.
4. DCC scope and services may be different to that expected by the workgroup and so could change the business requirements.
5. A concern was raised by one Supplier that GT read validations would not incentivise Shippers to carry out their own validations on the read and to submit accurate reads to the GT.
6. The same Supplier felt that if read validation was included in the regime that it should be an optional service which Suppliers could choose not to use. Other Suppliers did not agree with this approach, as read errors might not be detected and might affect charges for other parties.

#### **3.4 Constraints:**

1. Allocation processes commence at 1pm on the day following the Gas Day (GFD+1). Any new/amended processes identified in this document must co-ordinate with the existing Allocation timescales.
2. Final Calorific Value (CV) is not known until GFD+5; CV is used for the calculation of energy.

#### **3.5 Assumptions:**

1. Shippers will submit validated meter readings; not energy (kWh) or volume (consumption)
2. The requirement for aggregate reconciliation is expected to diminish or be replaced with meter point reconciliation.
3. Some LDZ sites will continue to be daily metered (and reads received daily) and their consumption is deducted from the allocation process

michele.downes 23/9/13 10:40  
Deleted: 0

Mike Berrisford 23/9/13 13:30  
Deleted: 23/09/2013

Mike Berrisford 23/9/13 13:30  
Deleted: 08/05/2013

4. A smearing mechanism for un-allocated energy will continue to be required
5. AUGE role and/or methodology may require amending via a Modification as a result of the revised settlement arrangements. This will be discussed at the Reconciliation Workgroup and any potential changes to the role of the AUGE will be documented in the Reconciliation BRD.
6. The business rules will need to be appropriate for dumb metered sites as well as remotely read sites
7. Continual monitoring to take place of SMIP developments to ensure alignment with parties obligations and DCC services
8. Energy allocation processes will continue to run at 1pm on GFD+1
9. Shippers will continue to have the obligation to submit reading data to the GT
10. Any additional Gas Transporters charges will be billed in line with User Pays principles where appropriate
11. "Must Reads" will continue to be a Gas Transporters responsibility.
12. There will continue to be a requirement in the gas industry to have Daily Metered sites where reads are obtained and submitted daily for the following two scenarios;
  - a. System critical (for network operation activities)
  - b. Process critical (for energy balancing & allocation processes)
13. The existing UNC requirements for a "Valid Meter Read" (M3.1.4) will continue to apply for the purposes of the Must Read requirement. A "Valid Meter Read" is an actual or transmitted reading where the following conditions are satisfied:
  - a. Meter Reading provided by a Meter Reader
  - b. Customer Reading
  - c. Meter Reading provided by means of a Remote Read
14. Only reads that have closed out (GFD+5) shall be classed as valid meter readings for the purposes of downstream processes, e.g. Reconciliation, AQ calculation.
15. A re-synchronisation is only required on certain types of metering equipment capable of transmitting derived daily reads.
16. All meter readings submitted to the GT will be subject to 'logic checks'. Any readings that fail these checks will be notified to the Shipper as per existing UNC rules (Section M).
17. Validation of meter readings will remain the responsibility of the Shipper.
18. Obligations on Shippers will need to continue to ensure that validation of the meter reading is carried out and only accurate reads are submitted to the GT.
  - a. The UNC Validation Rules document will need to be amended to reflect the changes.
  - b. The validation rules described under section 5.13 are the minimum requirement of validation that must be undertaken.
19. 'Exit Close Out' (GFD+5) continues as per existing UNC rules (Section E1.8):
  - a. 5<sup>th</sup> calendar day after the gas flow day.
20. To enable validation of reads it is recognised and accepted that an average LDZ CV value is used to calculate the energy in order to validate the read.
21. All reads obtained and submitted to the GT are taken at 06.00 hours, for dumb meters the read will be deemed to be taken at 06.00 hours.
22. CSEPs above the DM Mandatory threshold will be treated as DM directly connected sites and will be processed under 'Product 1'.

michele.downes 23/9/13 10:39
Deleted: 0
Mike Berrisford 23/9/13 13:30
Deleted: 23/09/2013
Mike Berrisford 23/9/13 13:30
Deleted: 08/05/2013

- 23. For Settlement purposes CSEP MPRs below the DM Mandatory threshold will be subject to NDM Allocation (consistent with Products 3 and 4). Reconciliation of these MPRs will be dealt with in the Reconciliation BRD.
- 24. The Check Read obligation will not default to the GT to fulfil; Check Reads will remain a Shipper responsibility.
- 25. Telemetered and NTS sites will be processed as DM Mandatory under Product 1.

### 3.6 Design Considerations

- 1. For Product 2 sites (Daily Metered Not Time Critical Readings), where a valid read is received before 10.00 am the read can be used for Allocation purposes instead of the estimated energy calculated for the purposes of Allocation. The solution will need to consider if the Allocation process should check for a read before estimating the allocation of energy for the site or check after the estimate has been calculated and override if a read from the Shipper has been loaded.
- 2. It is not presently feasible for Shippers to submit gas energy values (kWh) in a timely manner since calorific value (CV) is not available until after close-out at GFD+5. It would therefore not be possible at present for Shippers to submit kWh to meet the deadlines specified in Products 1 and 2 below. Whatever system solution is developed it should be flexible enough to cope eventually with the provision of either a meter reading, a volume reading, or an energy value. However, there are potential cost implications relating to the level of system complexity.
- 3. There are some parameters within the requirements that still require agreement. These are shown within square brackets [ ]. These values should not be 'hard coded' and should be set as a parameter value. These values may need to be clarified for the design and development phases.
- 4. Aspiration that there should be no volume constraints, limits on updates or data submitted to the GT.
- 5. Ensure the demand estimation algorithm can be easily changed & applied

### 3.8 Costing Options

michele.downes 23/9/13 10:39
<b>Deleted:</b> 0
Mike Berrisford 23/9/13 13:30
<b>Deleted:</b> 23/09/2013
Mike Berrisford 23/9/13 13:30
<b>Deleted:</b> 08/05/2013

## 4. Business Process

### 4.1 Current Process & Process Maps

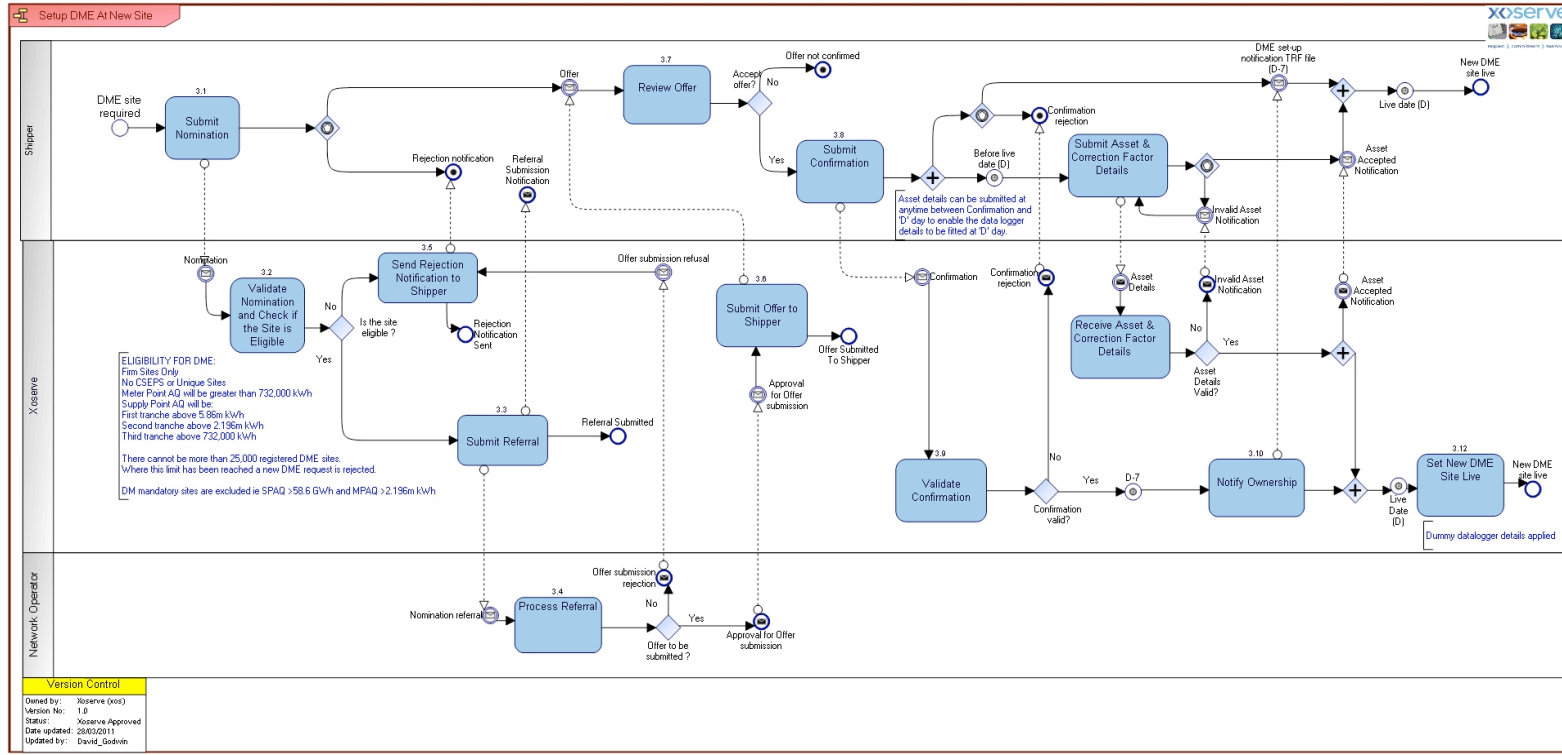

michele.downes 23/9/13 10:40

Deleted: 0

Mike Berrisford 23/9/13 13:30

Deleted: 08/05/2013

Mike Berrisford 23/9/13 13:30

Deleted: 24/04/2013

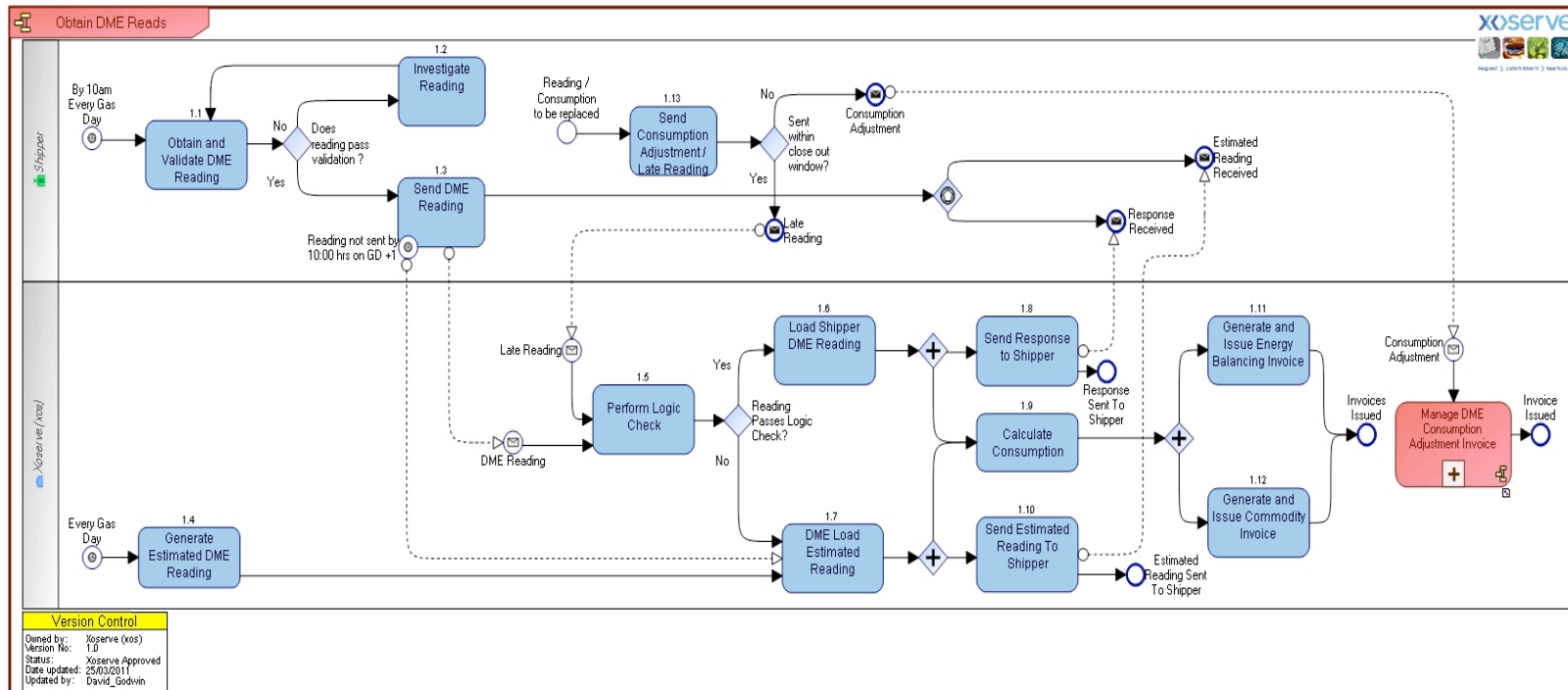

Reads to be submitted by a deadline. Any read submitted after the deadline will be processed the following day.

Validations carried out by xoserve on the read is a sense check only: 1. Whether the shipper is the Registered User, 2. Whether the reading has the correct number of digits

Zero consumptions will not be subject to validation, will be accepted based on the Shipper completing the validation prior to submission

Existing DM read estimation process is used: D-7 or AQ/365

Estimated reads can be replaced with an Actual read upto D+5

Actual reads can not be replaced

- michele.downes 23/9/13 10:40
- Deleted: 0**
- Mike Berrisford 23/9/13 13:30
- Deleted: 08/05/2013**
- Mike Berrisford 23/9/13 13:30
- Deleted: 24/04/2013**

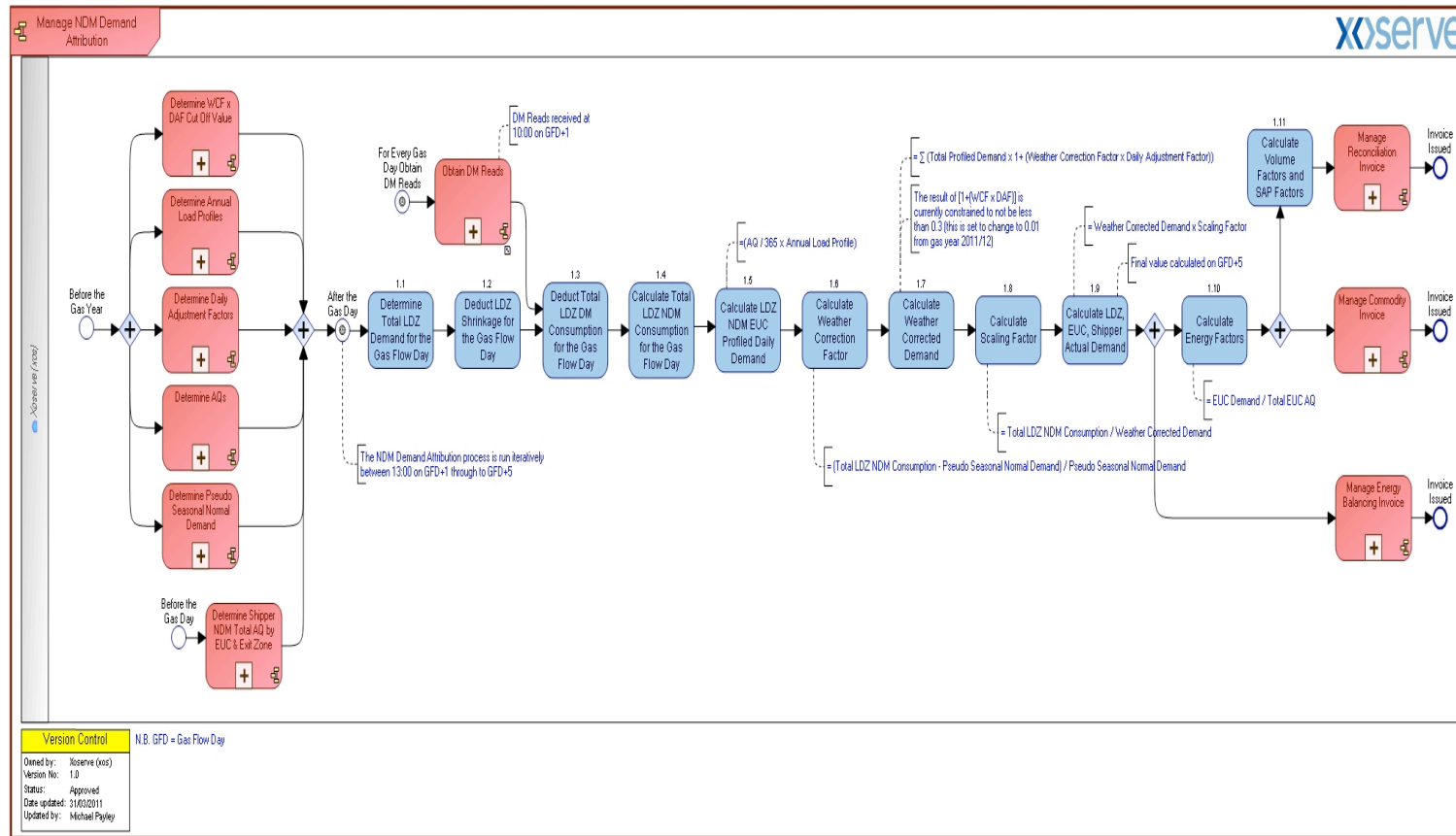

- michele.downes 23/9/13 10:40  
**Deleted: 0**
- Mike Berrisford 23/9/13 13:30  
**Deleted: 08/05/2013**
- Mike Berrisford 23/9/13 13:30  
**Deleted: 24/04/2013**

### 4.2 To Be Process & Process Map

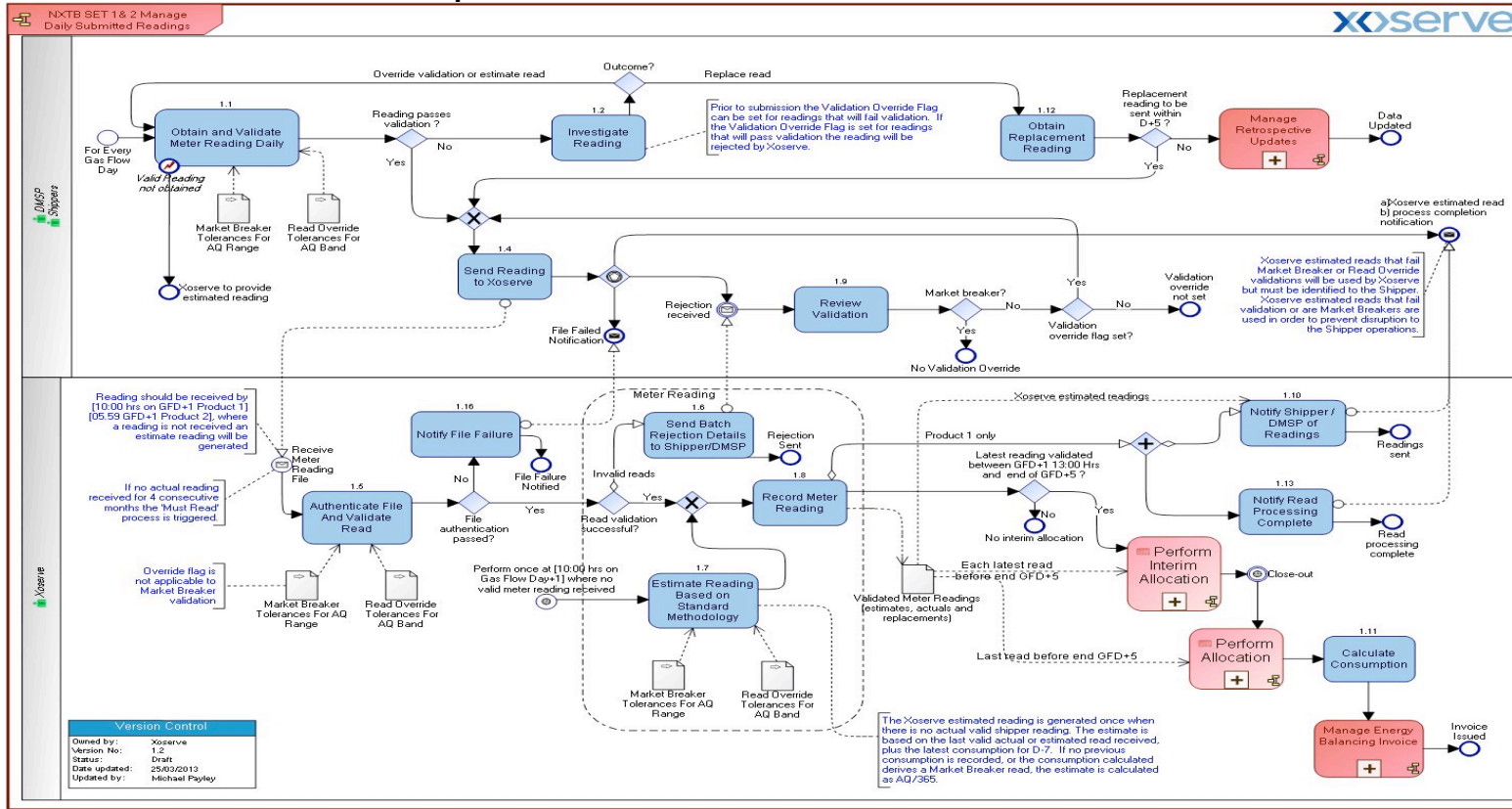

- michele.downes 23/9/13 10:40
- ~~Deleted: 0~~
- Mike Berrisford 23/9/13 13:30
- ~~Deleted: 08/05/2013~~
- Mike Berrisford 23/9/13 13:30
- ~~Deleted: 24/04/2013~~

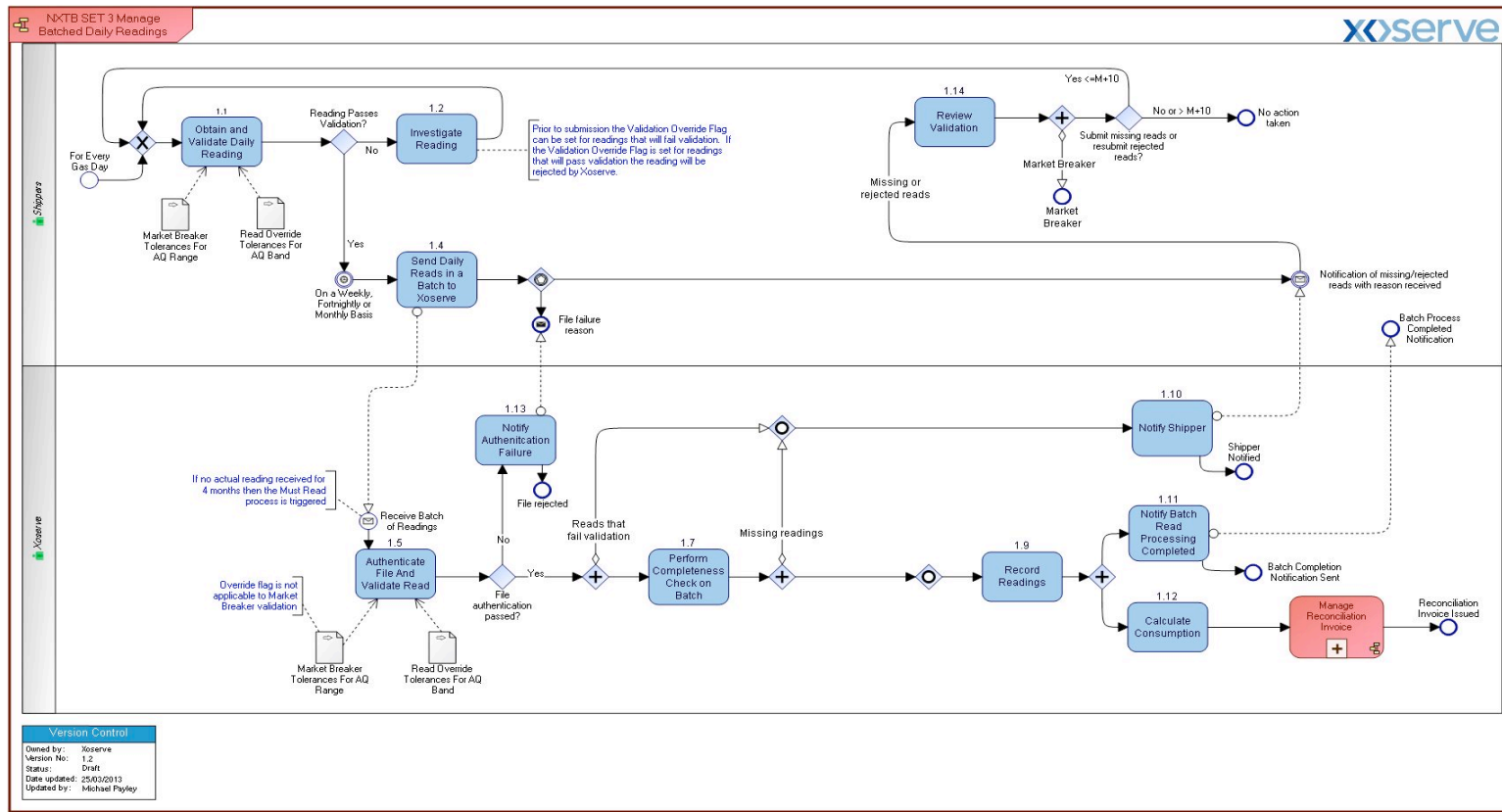

- michele.downes 23/9/13 10:40
- Deleted: 0**
- Mike Berrisford 23/9/13 13:30
- Deleted: 08/05/2013**
- Mike Berrisford 23/9/13 13:30
- Deleted: 24/04/2013**



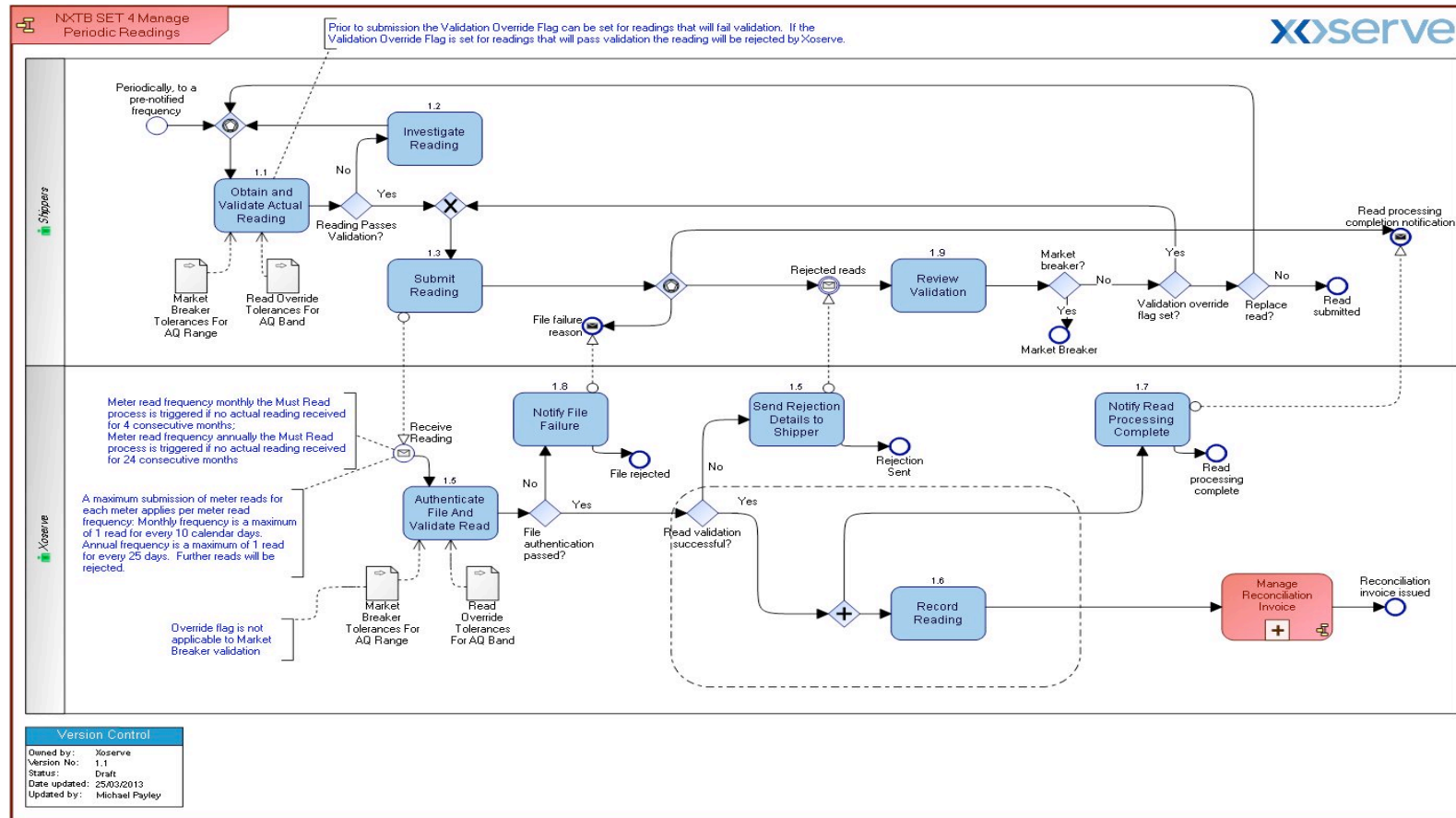

- michele.downes 23/9/13 10:40
- Deleted: 0**
- Mike Berrisford 23/9/13 13:30
- Deleted: 08/05/2013**
- Mike Berrisford 23/9/13 13:30
- Deleted: 24/04/2013**

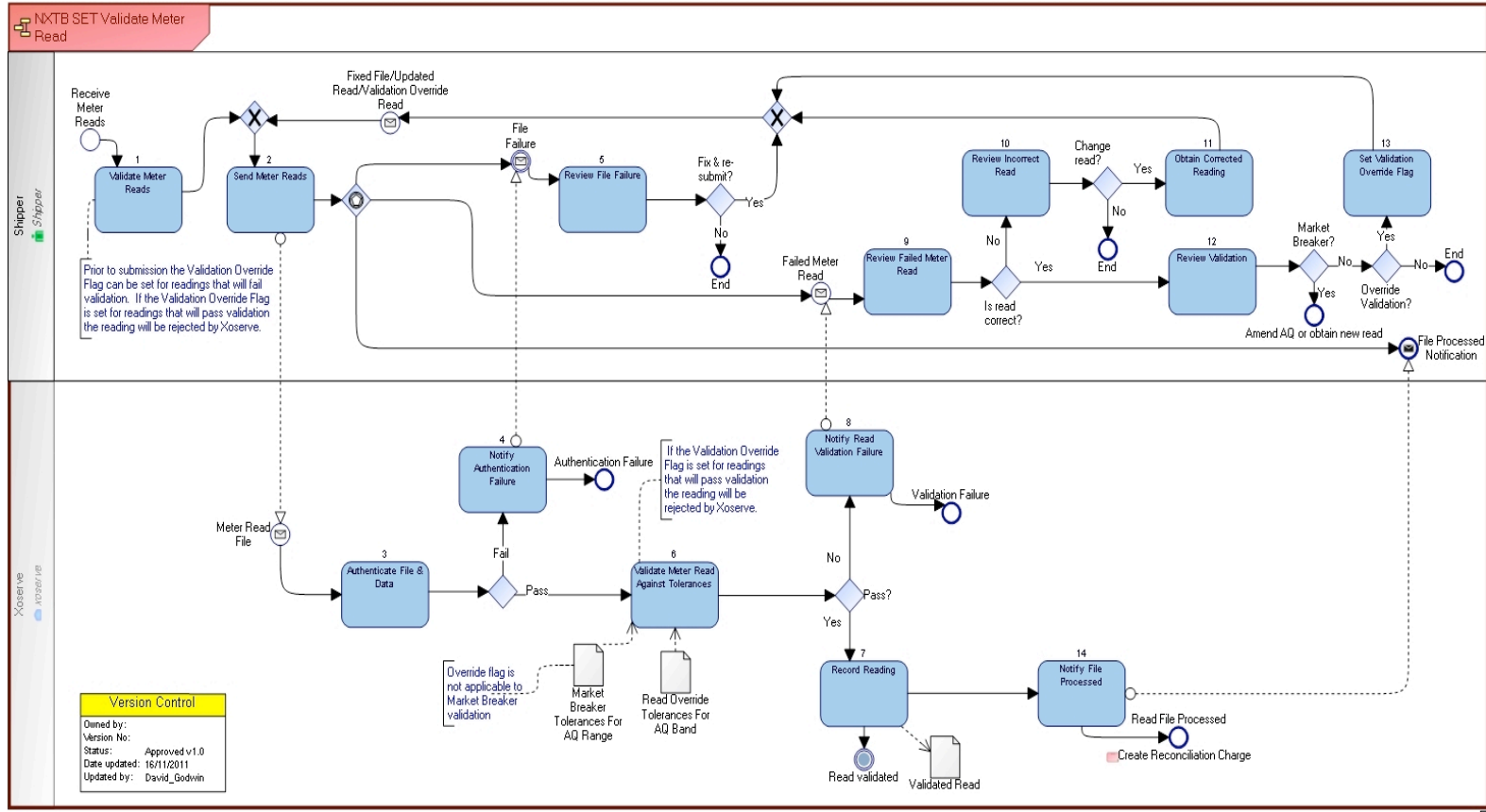

- michele.downes 23/9/13 10:40
- Deleted: 0**
- Mike Berrisford 23/9/13 13:30
- Deleted: 08/05/2013**
- Mike Berrisford 23/9/13 13:30
- Deleted: 24/04/2013**

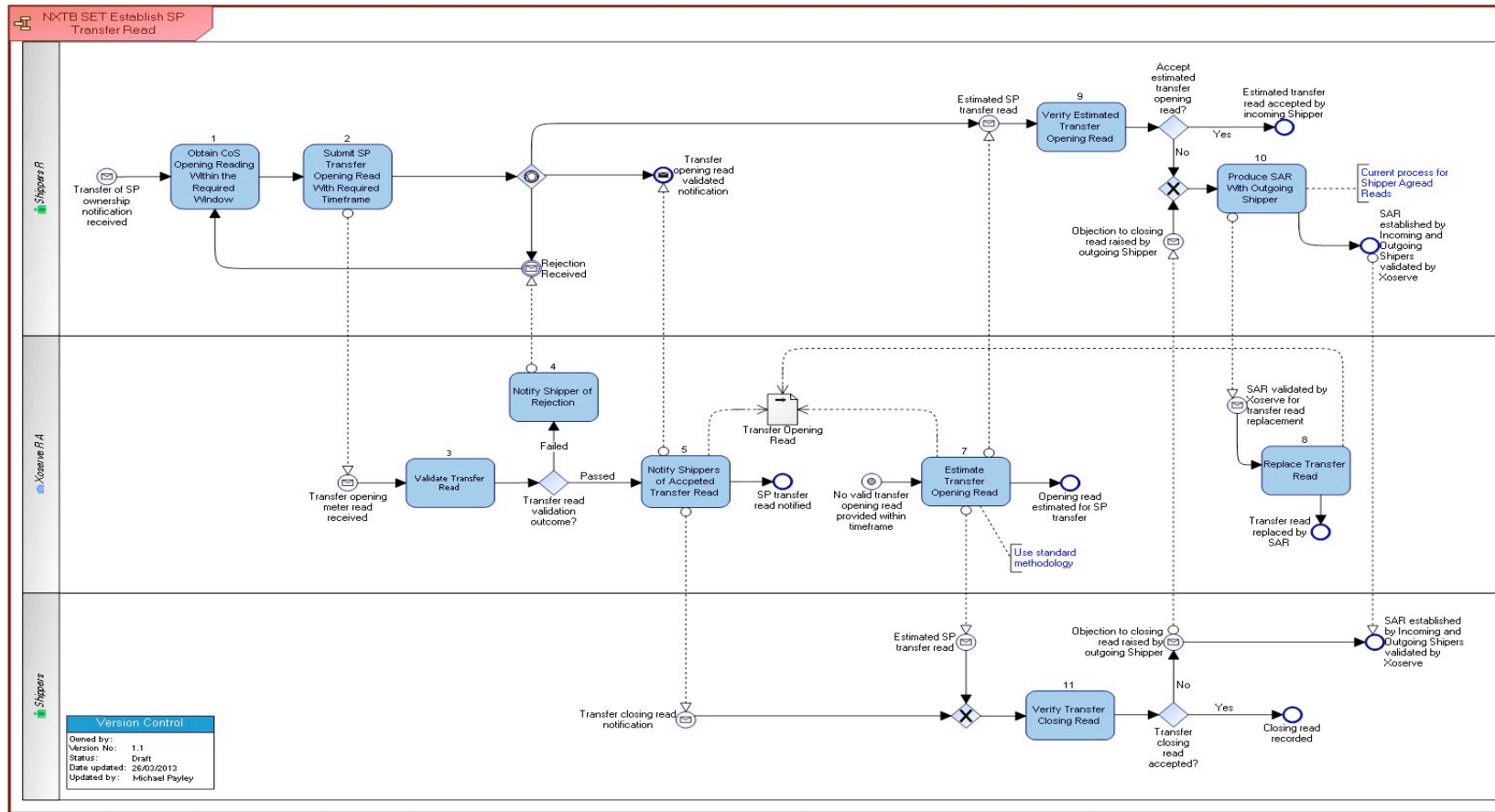

- michele.downes 23/9/13 10:40
- Deleted: 0**
- Mike Berrisford 23/9/13 13:30
- Deleted: 08/05/2013**
- Mike Berrisford 23/9/13 13:30
- Deleted: 24/04/2013**

## 5. Business Requirements Definition

### 5.1 Gas Nominations (before the day)

- 5.1.1 Shippers submit Nominations for Product 1 and 2 sites, where meter reads are submitted daily and used for allocation and Energy Balancing purposes.
- 5.1.2 Where a value for the gas nomination is not submitted by the Shipper for Product 1 and 2 sites a default value of D-7 will be used by the GT however, for scheduling charges purposes only; the D-7 value will be treated as zero. The default may be replaced as per existing rules by the Shipper.
- 5.1.3 GT calculates gas nominations on behalf of Shippers in aggregate for all sites in Products 3 and 4.
- 5.1.4 The same estimation methodology to be applied for Nominations as Allocations.
- 5.1.5 A 'Nominations Scaling Adjustment' (Smear) will be applied at LDZ level and Shipper portfolio level.

### 5.2 Energy Allocation and Balancing

- 5.2.1 For 'Daily Metered Time Critical' sites (Product 1) the reading loaded before 10.00 am on GFD +1 by the DMSP will be used for allocation purposes. Where a valid read is not received the GT will generate an estimate which can be replaced before the end of GFD+5.
- 5.2.2 For 'Daily Metered not Time Critical' sites (Product 2) if a valid read is received before 10.00 am on GFD+1 this will be used for the initial allocation purposes. Where a read is not loaded by the Shipper the GT will generate an estimate for allocation purposes.
- 5.2.3 For both 'Daily Metered Time Critical' sites and 'Daily Metered not Time Critical' sites the closed out energy balancing position will be based on the last valid read loaded (actual or estimate) before Close Out (GFD+5).
- 5.2.4 For sites within 'Batched Daily Readings' and Periodic Readings' (Products 3 & 4) the following rules will apply
  - 5.2.4.1. Daily energy allocation will be calculated on GFD+1 by the GT, the allocations will be refined as additional data is received until GFD+5 at close out.
  - 5.2.4.2. The process for energy allocation is described below under 'Estimation Methodology'
  - 5.2.4.3. The final closed out energy balancing position at GFD+5 will be based on the allocation profiles calculated by the GT

### 5.3 Estimation Methodology for GFD+1 Allocation

Workgroup agreed that a robust estimate is required for allocation purposes. An allocation process will still be required for Product 3 and 4 sites. The current algorithms used for NDM allocations may not be appropriate for Smart metered sites or a mix of smart and dumb metered sites.

michele.downes 23/9/13 10:40

Deleted: 0

Mike Berrisford 23/9/13 13:30

Deleted: 08/05/2013

Mike Berrisford 23/9/13 13:30

Deleted: 24/04/2013

DESC have reviewed the current methodology and developed new algorithms for before the day and after the day demand estimation. However, it is recognised that the proposed algorithm (Mod 0453) is an interim solution for approx. 2 years following implementation of the Project Nexus requirements. When more data is available new algorithms will be developed by DESC and will need to be applied.

**5.4 Share of Un-Identified Energy**

- 5.4.1 Each LDZ is balanced separately. The 'Allocations Scaling Adjustment' is calculated daily and applied to all sites within the LDZ
- 5.4.2 Shrinkage is deducted before un-identified energy is calculated
- 5.4.3 The share of un-identified energy is calculated as follows;
  - Total of all site consumptions (daily read sites) and the total of all estimates (via Allocation principles process for Products 3 and 4) will be combined daily to give the total LDZ consumption.
  - Compare total LDZ consumption to the total actual LDZ offtake (after Shrinkage deduction).
  - Allocation Scaling Adjustment % is calculated as:  

$$\frac{(\text{Actual LDZ offtake} - \text{Total LDZ site level consumption})}{\text{Total LDZ site level consumption}}$$
- 5.4.4 The difference between the two could be a positive or negative and will be apportioned equally to all sites within the LDZ; smart metered, DM, AMR and dumb meters.
- 5.4.5 All sites within the LDZ would receive the same % correction applied to the site's consumption for the day.
- 5.4.6 The Allocation Scaling Adjustment will be applied at LDZ and Shipper portfolio level, not at individual site level.
- 5.4.7 A positive value denotes an increase to site level consumption and a negative value would decrease the site level consumption.

Example:

Actual LDZ offtake	=	1,010,000 kWh
Total of individual Site level consumptions	=	1,000,000 kWh
Difference	=	10,000 kWh
Allocation Scaling Adjustment	=	+1%

+1% Allocation Scaling Adjustment (smear) applied to the consumption of all sites within the LDZ at Shipper portfolio level.

**5.5 Product 1 – Daily Metered Time Critical Readings**

- 5.5.1 This process applies to large sites where daily balancing is currently mandatory due to size, location interruptible contract or other factors. Timely receipt of reads is critical to the accuracy of the Allocation process for non daily read sites. This includes all Supply Points with an AQ >58.6m kWh, NTS and Telemetered sites.

michele.downes 23/9/13 10:50  
**Deleted:** The

michele.downes 23/9/13 10:49  
**Deleted:** Workgroup agreed that an expert group

michele.downes 23/9/13 10:49  
**Deleted:** to

michele.downes 23/9/13 10:49  
**Deleted:** , where appropriate,

michele.downes 23/9/13 10:49  
**Deleted:**

michele.downes 23/9/13 10:50  
**Deleted:** allocations

michele.downes 23/9/13 10:50  
**Deleted:** The expert group should be a sub-group of either DESC or PN UNC Workgroup with the appropriate DESC members.

michele.downes 23/9/13 10:40  
**Deleted:** 0

Mike Berrisford 23/9/13 13:30  
**Deleted:** 08/05/2013

Mike Berrisford 23/9/13 13:30  
**Deleted:** 24/04/2013

- 5.5.2 A reading must be submitted to the GT by the DMSP by 10am each day for the previous gas day (GFD+1).
- 5.5.3 The reading submitted will be an actual read (obtained from the device).
- 5.5.4 On receipt of a read the GT will perform 'Logic Checks' and validation on the read as described under Section 5.14. Notification will be issued by the GT to the DMSP detailing the meter readings that have failed the 'logic checks' or read validations.
- 5.5.5 If a valid reading is not received by 10am on GFD+1, the GT will estimate a reading.
- 5.5.6 The estimated reading will be calculated from the previous day's reading to produce an identical gas volume to the gas day 7 days earlier (a "D-7" estimate) or, if no previous consumption recorded for the site, the estimate will be calculated by  $AQ / 365$ .
- 5.5.7 All reads will be issued to the Registered Shipper by 11.00 am on GFD+1.
- 5.5.8 An estimated read can be replaced with an actual reading before Close Out (GFD+5).
- 5.5.9 Actual reads can not be replaced. Where the actual read loaded is incorrect (for example where the meter is identified as faulty) a Consumption Adjustment will be used to amend the consumption for the gas day.
- 5.5.10 The closed-out energy balancing position will be based on the last valid reading supplied (or calculated) before Close Out (GFD+5).
- 5.5.11 Replacement of reads after GFD+5 will be covered by the Retrospective Updates Business Rules.

## 5.6 Product 2 – Daily Metered Not Time Critical Readings

- 5.6.1 Sites for which Product 1 above is compulsory cannot use this process.
- 5.6.2 Between 10.00 am and 1.00 pm on GFD+1 the GT will estimate a reading for the purposes of Allocation. This reading will be calculated from the previous day's reading to produce an identical gas volume to the gas day 7 days earlier (a "D-7" estimate) or, if no previous consumption recorded, the estimate will be calculated by  $AQ / 365$ .
- 5.6.3 Where a valid read is loaded before 10.00 am on GFD+1 by the Shipper the reading will be used for the initial Allocation, the estimate described in section 5.6.2 will not be utilised for the purposes of Allocation.
- 5.6.4 If a reading has not been loaded by 10.00 am a valid reading must be submitted by the Shipper before the end of the day on GFD+1 (05.59 am following the gas day the meter reading relates to), see figure below for clarification of the timeline;

michele.downes 23/9/13 10:40
Deleted: 0
Mike Berrisford 23/9/13 13:30
Deleted: 08/05/2013
Mike Berrisford 23/9/13 13:30
Deleted: 24/04/2013

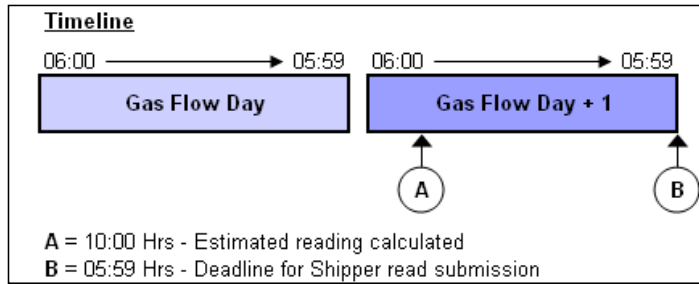

- 5.6.5 The reading submitted by the Shipper will be an actual read (obtained from the device)
- 5.6.6 If a valid reading is not received by the GT by end of the gas day on GFD+1 the GT will estimate the reading (this is the estimate calculated for Allocation purposes as described in 5.6.2) & notify the Shipper of the details after the read submission window closes.
- 5.6.7 The estimate can be replaced with an actual reading before close out (GFD+5)
- 5.6.8 All estimated reads will use a standard methodology under this process. The estimation methodology is described in section 5.6.2.
- 5.6.9 Actual reads can not be replaced. Where the actual read loaded is incorrect (for example where the meter is identified as faulty) a Consumption Adjustment will be used to amend the consumption for the gas day.
- 5.6.10 On receipt of a read the GT will perform 'Logic Checks' and validation on the read as described under Section 5.14. Notification will be issued by the GT to the Shipper detailing the meter readings that have failed the validations.
- 5.6.11 The closed-out energy balancing position will be based on the last reading supplied (or calculated) before end of GFD+5.
- 5.6.12 Replacement of reads after GFD+5 will be covered by the Retrospective Updates Business Rules.

**5.7 Product 3 – Batched Daily Readings**

- 5.7.1 Sites for which Product 1 above is compulsory cannot use this process.
- 5.7.2 Daily readings are not routinely submitted daily or within GFD+5 under this process.
- 5.7.3 Readings for each gas day are submitted periodically in batches, to a pre-notified frequency. These frequencies are weekly, fortnightly or monthly.
- 5.7.4 The maximum planned interval between the end dates of read batches under this process is monthly.
- 5.7.5 Each reading submitted within a batch will be an actual read (obtained from the device).

michele.downes 23/9/13 10:40  
**Deleted:** 0

Mike Berrisford 23/9/13 13:30  
**Deleted:** 08/05/2013

Mike Berrisford 23/9/13 13:30  
**Deleted:** 24/04/2013

- 5.7.6 Where a read is not received the GT will determine the consumption from the last actual reading to the next actual reading in accordance with existing Reconciliation principles.
- 5.7.7 A read file can contain reads for a mix of MPRN's with different read frequencies, for example, file contains 5 days consecutive reads for site A, 30 days consecutive reads for site B etc.
- 5.7.8 System 'Logic checks' will be carried out by the GT on the reads received from the Shipper. A 'completeness' check shall also be performed on receipt of the communication to ensure all reads expected have been received and validations performed on the read (detailed under Section 5.14)
- 5.7.9 For an MPRN, if there is a gap between the last reading date of the previous batch and the first reading date of the new batch, energy will be apportioned across the missing days. The apportionment methodology will be in accordance with existing Reconciliation processes.
- 5.7.10 For an MPRN, if there is a gap of one or more days within the sequence of reads in a batch, energy will be apportioned across the missing days. The apportionment methodology will be in accordance with existing Reconciliation processes.
- 5.7.11 A notification will be sent to the Shipper by the GT detailing the rejected reads and any days where a read was missing within a read communication file.
- 5.7.12 Replacement of readings after GFD+5 will be covered by the Retrospective Updates Business Rules.
- 5.7.13 On receipt of a batch of accepted reads the GT will perform individual daily reconciliations for each gas day up to and including the date of the last reading in the batch (see 5.7.9 and 5.7.10 above regarding filling in of missing/rejected reads).
- 5.7.14 Note: under this approach some readings are received within GFD+5, however these are not used for allocation & daily settlement, see diagram below:

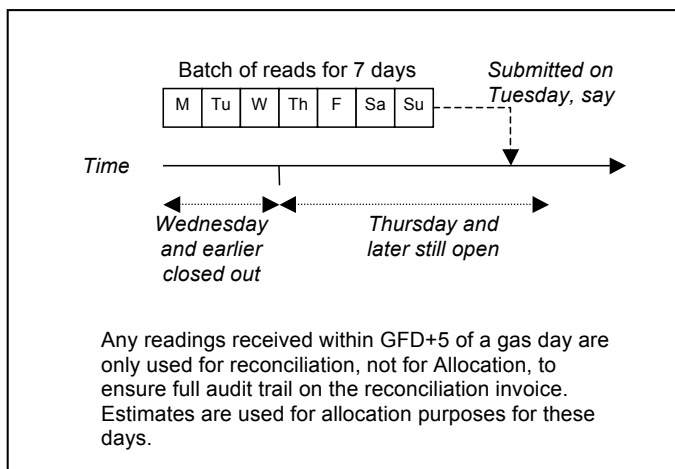

- michele.downes 23/9/13 10:40
- Deleted:** 0
- Mike Berrisford 23/9/13 13:30
- Deleted:** 08/05/2013
- Mike Berrisford 23/9/13 13:30
- Deleted:** 24/04/2013



5.7.15 Treatment of the resulting reconciliation will be determined under the Reconciliation Topic.

### 5.8 Product 4 – Periodic Readings

- 5.8.1 Sites for which Product 1. above is compulsory cannot use this process.
- 5.8.2 Daily readings are not submitted to the GT under this process, although the supplier and shipper may choose to receive these reads from the metering equipment.
- 5.8.3 A single actual meter reading is submitted periodically to a pre-notified frequency. The frequency can be monthly or annually subject to 5.8.4.
- 5.8.4 A Meter Point where the AQ equals or exceeds 293,000 kWh will have a meter read frequency of Monthly.
- 5.8.5 A maximum submission of meter reads to apply per meter read frequency. Where more than one meter reading is received in the period specified below, the latest reading will be rejected;
  - 1. Monthly Meter Reading Frequency: 7 calendar days
  - 2. Larger Annual Meter Reading Frequency: 14 calendar days
  - 3. Smaller Annual Meter Reading Frequency: 25 calendar days
- 5.8.6 The maximum planned interval for submission of readings under this process is annual.
- 5.8.7 The reads submitted will be actual reads and not estimated reads.
- 5.8.8 On receipt of a read the GT will perform 'Logic Checks' and validation on the read as described under Section 5.14. Notification will be issued by the GT to the Shipper detailing the meter readings that have failed validations as per section 5.14.
- 5.8.9 Replacement of readings will be covered by the Retrospective Updates Business Rules.
- 5.8.10 On receipt of a valid reading the GT will perform reconciliation since the last read date up to and including the date of the current reading, this will be covered in the Reconciliation BRD.

### 5.9 Change of Shipper

- 5.9.1 A Proposing Shipper can submit a Supply Point Enquiry to identify which Product and (for Products 3 & 4) the Meter Reading Frequency the site is registered under.
- 5.9.2 The Proposing Shipper to be notified of which Product currently applies and the current read frequency (where applicable) as well as the elected/proposed via the Confirmation response
- 5.9.3 A Proposing Shipper will need to specify on the existing Nomination and Confirmation communication the election of which Product and, for Products 3 & 4, the Meter Reading Frequency.
- 5.9.4 To ensure the relevant fields are populated the records submitted by the Shipper will be mandatory on the Nomination and Confirmation request; a default will not be applied.

michele.downes 23/9/13 10:40  
Deleted: 0

Mike Berrisford 23/9/13 13:30  
Deleted: 08/05/2013

Mike Berrisford 23/9/13 13:30  
Deleted: 24/04/2013

- 5.9.5 The Outgoing Shipper may continue to submit reads for D-1 of the transfer registration date upto the read submission deadline described under section 5.16;
- 5.9.6 A batch of reads (Product 3) or periodic read (Product 4) will be rejected where a valid transfer read has not been loaded or, where a read has not been loaded, following receipt of the GT estimated opening read (i.e. at D+16)

**5.10 Change of Shipper Transfer Reading**

- 5.10.1 For all Shipper transfers the following principles will apply for the submission and processing of the opening and closing meter reading.
  1. The Incoming Shipper has the obligation to obtain and submit the transfer read.
  2. Actual and estimated reads will be accepted for the transfer read. The read will be validated using the AQ/SOQ live at the time the read was received or, where applicable, the AQ that is due to go live (at D-5) as a result of the AQ review.
  3. Xoserve will generate an estimated read if a read is not received within the transfer read window
  4. The Shipper Agreed Read (SAR) process to continue for challenges to the transfer read
  5. Cyclic 'normal' reads will not be accepted for Products 3 & 4 until the transfer read has been loaded
  6. The prevailing Product type estimation methodology will be applied for estimating the transfer read.

5.10.2 Shipper Transfer to Product 1 from Products 2, 3 or 4.

Note: For a Shipper transfer but the site remains in Product 1 the DMSP will submit the transfer read.

1. The transfer read to be obtained on the transfer date and submitted by the DMSP by D+5.
2. The read will be subject to GT validations as discussed under section 5.14. Any reads that fail will be rejected and notification issued to the DMSP.
3. A valid transfer read submitted by the DMSP will be issued to the Incoming Shipper and Outgoing Shipper as the closing/opening read by the GT within [D+1] days of receipt.
4. For sites where a transfer read is not submitted by D+5 the GT will calculate an estimated transfer read and submit to both the Outgoing & Incoming Shipper as the closing/opening read on [D+6]. The estimate to be calculated as per the estimation methodology for Product 1
5. An estimated transfer read can be replaced if submitted & accepted within GFD+5.
6. The Incoming or Outgoing Shipper can challenge the estimated transfer read using the existing Shipper Agreed Read process (UNC M3.8). It will be the Incoming Shippers responsibility to submit the Shipper Agreed Read.

michele.downes 23/9/13 10:40  
Deleted: 0

Mike Berrisford 23/9/13 13:30  
Deleted: 08/05/2013

Mike Berrisford 23/9/13 13:30  
Deleted: 24/04/2013

7. A replacement read received after GFD+5 will be covered by Retrospective Updates.

5.10.3 Shipper Transfer from Product 1 to Products 2, 3 or 4

Note: For a Shipper transfer but the site remains in Product 1 the DMSP will submit the transfer read.

1. The transfer read to be obtained on the transfer date and submitted by the incoming Shipper by D+5.
2. The read will be subject to GT validations as discussed under section 5.14. Any reads that fail will be rejected and notification issued to the Shipper.
3. A valid transfer read submitted by the Shipper will be issued to the Outgoing Shipper as the closing read by the GT within [D+1] days of receipt.
4. For sites where a transfer read is not submitted by D+5 the GT will calculate an estimated transfer read and submit to both the Outgoing & Incoming Shipper as the closing/opening read on [D+6]. The estimate to be calculated as per the estimation methodology for the new Product
5. An estimated transfer read can be replaced if submitted & accepted within GFD+5.
6. The Incoming or Outgoing Shipper can challenge the transfer read using the existing Shipper Agreed Read process (UNC M3.8). It will be the Incoming Shippers responsibility to submit the Shipper Agreed Read.
7. A replacement read received after GFD+5 will be covered by Retrospective Updates.

5.10.4 Shipper Transfer to and from Product 2

Note: This does not include transfer involving Product 1, see 5.10.2 & 5.10.3

1. The transfer read to be obtained on the transfer date and submitted by the Shipper by D+5.
2. The read will be subject to GT validations as discussed under section 5.14. Any reads that fail will be rejected and notification issued to the Shipper.
3. A valid transfer read submitted by the Shipper will be issued to the Outgoing Shipper as the closing read by the GT within [D+1] days of receipt.
4. For sites where a transfer read is not submitted by D+5 the GT will calculate an estimated transfer read and submit to both the Outgoing & Incoming Shipper as the closing/opening read on [D+6]. The estimate to be calculated as per the estimation methodology for the Product
5. An estimated transfer read can be replaced if submitted & accepted within GFD+5.
6. The Incoming or Outgoing Shipper can challenge the transfer read using the existing Shipper Agreed Read process (UNC M3.8). It will be the Incoming Shippers responsibility to submit the Shipper Agreed Read.
7. A replacement read received after GFD+5 will be covered by Retrospective Updates.

5.10.5 Shipper transfer to Product 3 and from Product 3 to Product 4

michele.downes 23/9/13 10:40
Deleted: 0
Mike Berrisford 23/9/13 13:30
Deleted: 08/05/2013
Mike Berrisford 23/9/13 13:30
Deleted: 24/04/2013

Note: This does not include transfer involving Product 1, see 5.10.2 & 5.10.3

1. The transfer read to be obtained on the transfer date and submitted by the Shipper by D+10.
  2. The read will be subject to GT validations as discussed under section 5.14. Any reads that fail will be rejected and notification issued to the Shipper.
  3. A valid transfer read submitted by the Shipper will be issued to the Outgoing Shipper as the closing read by the GT within [D+1] days of receipt.
  4. For sites where a transfer read is not submitted by D+10 the GT will calculate an estimated transfer read and submit to both the Outgoing & Incoming Shipper as the closing/opening read on [D+15]. The estimate to be calculated as per the estimation methodology for the Product
  5. An estimated transfer read can be replaced if submitted & accepted within GFD+10.
  6. The Incoming or Outgoing Shipper can challenge the transfer read using the existing Shipper Agreed Read process (UNC M3.8). It will be the Incoming Shippers responsibility to submit the Shipper Agreed Read.
  7. A batch of reads or periodic read for dates after the transfer read window can not be submitted until a valid transfer read is loaded. Where a communication is received containing a batch of reads or periodic read it will be rejected by the GT.
  8. To clarify, if a transfer read is not loaded by the Shipper a batch of reads (Product 3) or periodic read (Product 4) can not be submitted until [D+16] when the estimate generated by the GT has been loaded and notified to the Shipper.
  9. The transfer read (read taken on the transfer effective date) may be contained within the read communication containing the batch of reads (Product 3) and will be accepted as the transfer read if valid and received within D+10 of the transfer date
  10. A replacement read received after GFD+5 will be covered by Retrospective Updates.
- 5.10.6 Shipper transfer between Product 4:
1. The read to be obtained between D-5 and D+5 (11 calendar day period) of the transfer date
  2. The transfer read must be submitted within D+10 business days of the transfer date.
  3. The transfer read will be subject to GT validations as discussed under section 5.14. Any reads that fail will be rejected and notification issued to the Shipper
  4. A valid transfer read submitted by the Incoming Shipper will be issued to the Outgoing Shipper as the closing read by the GT within [D+2] of receipt of the read.
  5. Where a read has not been loaded by the Incoming Shipper for the transfer date the GT will estimate the read based on the estimation methodology for the process and submit the estimate to the Incoming and Outgoing Shipper as the Opening/Closing read on [D+15] business days.

michele.downes 23/9/13 10:40
<b>Deleted:</b> 0
Mike Berrisford 23/9/13 13:30
<b>Deleted:</b> 08/05/2013
Mike Berrisford 23/9/13 13:30
<b>Deleted:</b> 24/04/2013

6. The Incoming or Outgoing Shipper can challenge the transfer read using the existing Shipper Agreed Read process. It will be the Incoming Shippers responsibility to submit the Shipper Agreed Read.

Note: Transfer Read Timeline matrix is shown under Appendix 1

### 5.11 Election for change in Read Frequency or Regime where there is no change in Shipper

- 5.11.1 A Meter Point where the AQ equals or exceeds 293,000 kWh will have a meter read frequency of Monthly. This applies to Products 4 only.
- 5.11.2 Change in meter read frequency: The GT needs to know [2] business days before the gas day of the elected read frequency (Products 3 & 4 only) for planning and estimation purposes. A change in Meter Reading Frequency can only be effective [2 months] after the current Meter Reading Frequency effective date, except where;
  1. There has been a change of Shipper.
  2. There has been a change of tenancy
  3. There has been a meter exchange or change of equipment (i.e. dumb to Smart)
- 5.11.3 Change in regime: An election for a change of regime must be received and accepted by [2] business days before the gas day of the elected regime. A change in regime can only be effective 2 months after the current regime effective date except where;
  4. There has been a change of Shipper.
  5. There has been a change of tenancy
  6. There has been a meter exchange or change of equipment (i.e. dumb to Smart)
- 5.11.4 Only the Registered User or a Confirming User (with a confirmation about to become effective after D-7) can submit an election described in section 5.11.2 or 5.11.3. If the requesting User will not be the Registered User on the day to which the election refers, the election will be rejected.
- 5.11.5 A meter reading is not necessary for a change in Regime only as;
  - For a change to or from Products 1, 2 or 3: the read taken for the gas day will be used to close out the previous period.
  - For a change to Product 4: the read taken on D-1 will be used as the transfer read. If a transfer read is received it will be accepted as the transfer reading, subject to validation.

### 5.12 Read Communication Content

- 5.12.1 Information exchange from the Shipper to the GT;
  1. MPRN
  2. Meter Serial Number
  3. Reading
  4. Date of Reading

michele.downes 23/9/13 10:40
Deleted: 0
Mike Berrisford 23/9/13 13:30
Deleted: 08/05/2013
Mike Berrisford 23/9/13 13:30
Deleted: 24/04/2013

5. Through the Zero Count
  6. Actual or Estimated Transfer Reading
  7. Derived or Actual Read
  8. Read Reason Code (includes but not limited to Opening Read, Replacement Reading, Check Read)
  9. Converter Reading
  10. Read Validation Override Flag
- 5.12.2 All records will be Mandatory except 'Converter Reading' & 'Read Validation Override Flag' which will be Optional fields and 'Derived or Actual' which will be conditional if the reading is an actual read.
- 5.12.3 If the 'Read Validation Override Flag' is populated the read will not be validated against the checks described under Section 5.14 'Override Read Tolerance', however, the existing validations (logic checks) on the other fields for the MPRN will be performed and if any of the records fail the 'logic checks' the read will be rejected and the reason for the rejection contained within the notification to the Shipper.
- 5.12.4 Existing validations (logic checks) on the data within the read communication will be carried out by the GT on receipt of the read communication; any fields that fail the validations will be rejected and notified to the Shipper.
- 5.12.5 Where replacement read(s) are submitted this will need to be stated on the read communication else the read will be rejected as a 'duplicate'
- 5.12.6 Information Exchange from the GT to the Shipper;
1. Response: 'File' Level
    - a. Total Number of Reads Received
    - b. Total Number of Accepted Reads
    - c. Total Number of Rejected Reads
  2. Response: At MPRN Level for rejected or missing reads only:
    - a. MPRN
    - b. Reading
    - c. Date of Reading
    - d. Rejected Indicator
    - e. Rejected Reason Code
  3. Estimated Read Notification;
    - a. Estimated Reading
    - b. Date of Estimated Reading
    - c. Reason Code for Estimated Reading (e.g. read failed validation, no read received)
    - d. Notification where the read failed the GT read validations
- 5.12.7 For rejected reads only, where the rejection is due to the data supplied by the Shipper not matching the data held on the Supply Point Register, e.g. asset data, a separate file will be issued to the Shipper notifying them of

michele.downes 23/9/13 10:40
<b>Deleted:</b> 0
Mike Berrisford 23/9/13 13:30
<b>Deleted:</b> 08/05/2013
Mike Berrisford 23/9/13 13:30
<b>Deleted:</b> 24/04/2013

the data items held on the Supply Point Register which did not match with the data held on the read file. This will be sent as a supporting file separate to the read communication file.

### 5.13 Shipper Read Validation

5.13.1 This section describes the minimum requirement of validation that must be undertaken on readings by the Shipper before submission to the GT. The validation described in 5.13.2 and 5.13.3 will be in addition to that used to determine that the data is in accordance with the file specification and system requirements.

#### 5.13.2 Daily Read(s);

Shipper validation carried out on all daily reads received, either a read received daily or daily reads received at set intervals;

1. A completeness check to ensure that all readings expected have been received, including Converter readings where installed.
2. Tolerance check to ensure the energy derived from the reading is within the specified tolerance for the AQ band, as per the table below;
3. A reading which produces a negative energy will only be accepted following an estimated read

#### Read Validation Tolerances on receipt of a daily read following an Actual Read.

The read is acceptable if the consumption falls within the following tolerances.

Lower AQ band (kWh)	Upper AQ band (kWh)	Override Read Tolerance (can override with 'flag')
0	73,200	[0 - 73,200] kWh
73,201	732,000	[10% - 100%] of SOQ
732,001	2,196,000	[10% - 100%] of SOQ
2,196,001	29,300,000	[10% - 100%] of SOQ
29,300,001	58,600,000	[10% - 100%] of SOQ
58,600,001	and above	[10% - 100%] of SOQ

#### Read Validation Tolerances on receipt of a daily read following an Estimated Read.

The read is acceptable if the consumption falls within the following tolerances.

Lower AQ band (kWh)	Upper AQ band (kWh)	Override Read Tolerance (can override with 'flag')
0	73,200	No greater than + or - 73,200 kWh
73,201	732,000	[+ or - 100%] of SOQ
732,001	2,196,000	[+ or - 100%] of SOQ
2,196,001	29,300,000	[+ or - 100%] of SOQ
29,300,001	58,600,000	[+ or - 100%] of SOQ
58,600,001	and above	[+ or - 100%] of SOQ

michele.downes 23/9/13 10:40

Deleted: 0

Mike Berrisford 23/9/13 13:30

Deleted: 08/05/2013

Mike Berrisford 23/9/13 13:30

Deleted: 24/04/2013

5.13.3 Periodic Read

Shipper validation carried out for periodic reads received;

1. Tolerance check to ensure the energy from the reading is within the specified tolerance for the AQ band, as per the table below;

The read is acceptable if the consumption falls within the following tolerances.

Lower AQ band (kWh)	Upper AQ band (kWh)	Override Read Tolerance (can override with 'flag')
0	73,200	[20% - 300%] of AQ/365 x no. of days
73,201	732,000	[20% - 250%] of AQ/365 x no. of days
732,001	2,196,000	[20% - 200%] of AQ/365 x no. of days
2,196,001	29,300,000	[20% - 150%] of AQ/365 x no. of days
29,300,001	58,600,000	[20% - 100%] of AQ/365 x no. of days
58,600,001	and above	[20% - 100%] of AQ/365 x no. of days

Note: See appendix 2 for a diagram explaining the read validation tolerances

5.14 GT Read Validation

- 5.14.1 Existing validation of the read communication specification and data within the file matching the data held on the Supply Point Register will continue, for example mandatory fields are populated, Shipper exists as a Registered User, field lengths, 'fuzzy match' on the meter serial number etc.
- 5.14.2 Further check carried out at file level on the number of reads rejected within a file communication; where x% of reads have failed reject the whole file.
- 5.14.3 Further checks will be performed by the GT on the meter reading. These checks are aimed at protecting the industry by ensuring erroneous reads are not loaded into the system and used for deriving AQ, energy allocation and reconciliation processes.
- 5.14.4 Two tests will be carried out on receipt of the read, actual and estimated, based on a tolerance for an AQ band, these are detailed under 5.14.4 and 5.14.5.
- 5.14.5 Initial test on the read performed by the GT will include the following (not in any order):
  2. A meter read submitted which is outside of the read submission deadline (see section 5.16) will be rejected.
  3. For Product 4, the maximum read submission limit is exceeded, see Section 5.8.5.
  4. For sites in Products 1, 2 & 3, a completeness check to ensure that all readings expected have been received.

michele.downes 23/9/13 10:40  
Deleted: 0

Mike Berrisford 23/9/13 13:30  
Deleted: 08/05/2013

Mike Berrisford 23/9/13 13:30  
Deleted: 24/04/2013



5. For sites in Products 1 & 2, reject if the read produces a negative energy except after an estimated read.
  6. For sites in Product 3 & 4, reject if the read produces a negative energy except after an estimated transfer read
  7. Validation to ensure the read follows on from a previous actual reading.
  8. The GT validations on the meter reading will replicate the minimum Shipper read validations described above in section 5.13.2 and 5.13.3
  9. Where the read has failed any of the above validations the read will be rejected and a notification issued to the Shipper.
  10. Where the Shipper identifies that a read will fail the GT validations the Shipper has the facility to flag the read as correct via the read communication 'Read Validation Override Flag' which will bypass the tolerance checks described in 5.13.2 and 5.13.3.
  11. The 'Read Validation Override Flag' can be populated on the first submission of the read or following rejection from the GT.
  12. Where a read has been flagged with the Read Validation Override Flag but, according to the GT validation the read would not fail the tolerance checks, the read will be rejected as having been incorrectly flagged.
  13. All meter reads, except meter installation reads, will be subject to validation.
  14. Consumption adjustments will be subject to the tolerance checks.
- 5.14.6 The second test on the read is aimed at ensuring significant erroneous reads, referred to as 'Market Breakers', are not loaded into the system and used in allocation, reconciliation and AQ processes.
1. If the read fails the checks it will be rejected and the Shipper notified. If a read fails due to the 'Market Breaker' check it can not be overridden using the 'Read Validation Override Flag'
  2. The validation on the read is detailed in the tables below, section 5.14.6. The read will be accepted if within the tolerance described for each AQ band;
- 5.14.7 The two tests of read validation tolerances are detailed in the tables below. The first column 'Override Read Tolerance' replicates the minimum Shipper read validation tolerances described in section 5.13.2 and 5.13.3;
- 5.14.8 The AQ/SOQ used to validate the read will be the current 'live' AQ/SOQ. Where a revised AQ has been calculated and confirmed (at D-5), the revised values will be used to validate the read.

Read validation tolerances on receipt of a daily read following an Actual Read. Read would be accepted if the consumption falls within the following tolerances.

Lower AQ band (kWh)	Upper AQ band (kWh)	Override Read Tolerance (can override with 'flag')	'Market Breaker' Read Tolerance (can not override with 'flag')
0	73,200	[0 - 73,200] kWh	[0 – 700%] of SOQ

michele.downes 23/9/13 10:40  
Deleted: 0

Mike Berrisford 23/9/13 13:30  
Deleted: 08/05/2013

Mike Berrisford 23/9/13 13:30  
Deleted: 24/04/2013

73,201	732,000	[10% - 100%] of SOQ	[0 - 650%] of SOQ
732,001	2,196,000	[10% - 100%] of SOQ	[0 - 600%] of SOQ
2,196,001	29,300,000	[10% - 100%] of SOQ	[0 - 550%] of SOQ
29,300,001	58,600,000	[10% - 100%] of SOQ	[0 - 500%] of SOQ
58,600,001	and above	[10% - 100%] of SOQ	[0 - 450%] of SOQ

Read validation tolerances on receipt of a daily read following an Estimated Read.  
 Read would be accepted if the consumption falls within the following tolerances.

Lower AQ band (kWh)	Upper AQ band (kWh)	Override Read Tolerance (can override with 'flag')	'Market Breaker' Read Tolerance (can not override with 'flag')
0	73,200	No greater than + or - 73,200 kWh	[+ or - 700%] of SOQ
73,201	732,000	[+ or - 100%] of SOQ	[+ or - 650%] of SOQ
732,001	2,196,000	[+ or - 100%] of SOQ	[+ or - 600%] of SOQ
2,196,001	29,300,000	[+ or - 100%] of SOQ	[+ or - 550%] of SOQ
29,300,001	58,600,000	[+ or - 100%] of SOQ	[+ or - 500%] of SOQ
58,600,001	and above	[+ or - 100%] of SOQ	[+ or - 450%] of SOQ

Read validation tolerances on receipt of a periodic read. Read would be accepted if the consumption falls within the following tolerances.

Lower AQ band (kWh)	Upper AQ band (kWh)	Override Read Tolerance (can override with 'flag')	'Market Breaker' Read Tolerance (can not override with 'flag')
0	73,200	[20% - 300%] of AQ/365 x no. of days	[0 - 700%] of AQ/365 x no. of days
73,201	732,000	[20% - 250%] of AQ/365 x no. of days	[0 - 650%] of AQ/365 x no. of days
732,001	2,196,000	[20% - 200%] of AQ/365 x no. of days	[0 - 600%] of AQ/365 x no. of days
2,196,001	29,300,000	[20% - 150%] of AQ/365 x no. of days	[0 - 550%] of AQ/365 x no. of days
29,300,001	58,600,000	[20% - 100%] of AQ/365 x no. of days	[0 - 500%] of AQ/365 x no. of days
58,600,001	and above	[20% - 100%] of AQ/365 x no. of days	[0 - 450%] of AQ/365 x no. of days

5.14.9 Estimates calculated by the GT will be subject to the "market breaker" validations described under section 5.14.6. However, any reads which fail either the Override Tolerance or the Market Breaker tolerance will still be loaded, but a warning message will be issued to the relevant Shipper. The Shipper may chose to replace the reading before or after D+5. GT

michele.downes 23/9/13 10:40
Deleted: 0
Mike Berrisford 23/9/13 13:30
Deleted: 08/05/2013
Mike Berrisford 23/9/13 13:30
Deleted: 24/04/2013

estimates are based on D-7 volumes, which have been subject to validation. GT estimate is the fallback in the event of no Shipper reading, and a default zero or other value would be unacceptable to integrity of Allocation.

**5.15 Read Submission Performance Targets**

- 5.15.1 Read Submission targets will continue to be required for the submission and acceptance of actual valid meter readings by Shippers.
- 5.15.2 This will be based on a percentage of the shipper's portfolio as described below;
  - 1. Product 1 :97.5% of sites in the Shippers portfolio per calendar day
  - 2. Product 2: 97.5% of sites in the Shippers portfolio per calendar day
  - 3. Product 3:
    - a. For LSP: 90% of sites in the Shippers portfolio per calendar month
    - b. For SSP: 90% of sites in the Shippers portfolio per calendar month
  - 4. Product 4:
    - a. For Monthly Read Meters: 90% of sites in the Shippers portfolio per calendar month
    - b. For SSP Annual Read Meters: 70% of sites in the Shippers portfolio in a 12 month period
    - c. For LSP Annual Read Meters: 90% of sites in the Shippers portfolio in a 12 month period
- 5.15.3 Reports will be produced monthly showing the achieved read performance per Shipper.

**5.16 Read Submission Deadline**

- 5.16.1 A read submission deadline will ensure valid readings are submitted within a set period after the meter read date. This does not include transfer reads.
- 5.16.2 For Products 1 and 2; 5 calendar days after the meter read date (GFD+5). Meter readings submitted after D+5 of the date of the meter read for Products 1 & 2 will be described in the Retrospective Updates or Reconciliation BRD.
- 5.16.3 A meter reading not received within the following deadline for Products 3 & 4 will be rejected unless they are replacement reads.
  - 1. Product 3: Month + 10 (maximum 41) calendar days following the date of the meter read
  - 2. Product 4: 25 calendar days following the date of the meter read

**5.17 Must Reads**

- 5.17.1 The Must Read requirement will apply where an actual 'Valid Meter Read' is not received for a consecutive period of time as per 5.17.2

michele.downes 23/9/13 10:40

**Deleted:** 0

Mike Berrisford 23/9/13 13:30

**Deleted:** 08/05/2013

Mike Berrisford 23/9/13 13:30

**Deleted:** 24/04/2013

5.17.2 A Must Read will be initiated when;

1. Product 1: not applicable
2. Product 2: a read has not been loaded for 4 consecutive months
3. Product 3: a read has not been loaded for 4 consecutive months
4. Product 4:
  - a. where the read frequency is monthly and a read has not been loaded for 4 consecutive months
  - b. where the read frequency is annual and a read has not been received for 24 consecutive months

### 5.18 Check Read

5.18.1 Check Read obligations will continue to apply to detect any drift between the meter & AMR equipment. Check Read requirement will apply for sites fitted with metering equipment that derive reads, for those sites in this category the following timescales for the Check Read requirement will apply;

1. Product 1: Every 12 months
2. Product 2: Every 12 months
3. Product 3: Every 12 months
4. Product 4:
  - a. where the read frequency is monthly every 12 months
  - b. where the read frequency is annual every 24 months

5.18.2 The GT will notify the Registered User of the MPRN and date the Check Read was due [1] month after the Check Read due date.

1. In order to do this the relevant data items to monitor the Check Read requirement will need to be recorded by the GT.

### 5.19 Other requirements

5.19.1 Because third parties may also be submitting readings on behalf of the Shipper, an audit trail is required to identify which party submitted the reading.

5.19.2 Receipt of the read and notifications of accepted and rejected reads will be notified to the submitting party.

michele.downes 23/9/13 10:40
<b>Deleted:</b> 0
Mike Berrisford 23/9/13 13:30
<b>Deleted:</b> 08/05/2013
Mike Berrisford 23/9/13 13:30
<b>Deleted:</b> 24/04/2013

## 6. Non-Functional Business Requirements

### 6.1 Volume

Shipper aspiration is for no limits or system constraints on the daily volume of reads that can be submitted. Xserve initial expectations following discussions at the Workgroups is larger I&C sites will adopt Products 1, 2 or 3 where daily reads are submitted. Smaller I&C sites and domestic sites are likely to use Products 3 & 4 during Smart metering rollout.

Based on this expectation the following volumes are only an estimated guide at this time of the potential volumes for each product. A more accurate view of possible volumes will be required for cost benefit analysis and system design at a later stage. Consideration of possible volumes may also be required for potential future volumes per Product.

Product 1: Daily Metered Time Critical 1,000 to 2,000 meter points

Product 2: Daily Metered not Time Critical 1,500 to 29,000 meter points

Product 3: Batched Daily Readings 1,500 to 10,000,000 meter points

Product 4: Periodic Readings upto 21,500,000 meter points

### 6.2 File Level Validation

Where X% of the records within a file fail the whole file will be rejected back to the Shipper or submitting party.

### 6.3 Bulk updates/transfers

Requirement to update or transfer a large number of meter points between Products or Meter Read Frequency to be included.

michele.downes 23/9/13 10:40
Deleted: 0
Mike Berrisford 23/9/13 13:30
Deleted: 08/05/2013
Mike Berrisford 23/9/13 13:30
Deleted: 24/04/2013

## 7. Appendices

Appendix 1:



Y:\Shared\  
NGSRV51H003\TeamC

Appendix 2



Y:\Shared\  
NGSRV51H003\TeamC

michele.downes 23/9/13 10:40
<b>Deleted:</b> 0
Mike Berrisford 23/9/13 13:30
<b>Deleted:</b> 08/05/2013
Mike Berrisford 23/9/13 13:30
<b>Deleted:</b> 24/04/2013

## 8. Glossary

Term / Acronym	Definition
Actual read	Where the read transmitted or procured is an actual read and not an estimated read
Allocation	Determination of daily gas offtaken for a site
AUGE	Allocation of Unidentified Gas Expert
Derived read	Where a read is derived or calculated using pulses from the kit attached to the meter
DESC	Demand Estimation Sub Committee
DM Mandatory	As defined in UNC Section G1.5. Daily Read requirement applies where the Supply Point AQ is greater than 58,600,000 kWh.
DM Unbundling	Current obligations are on the GT to provide daily read equipment & daily reads to Shippers. 'Unbundling' is the term used for transferring the obligations from the GTs to the Shippers/Suppliers.
GFD	Gas Flow Day
GFD+5	Exit Close Out which is 5 calendar days after the Gas Flow Day. Also known as D+5.
Incoming Shipper	Newly appointed Shipper to take ownership for the Supply Point
Logic Checks	Validation carried out by the GT on receipt of the read. Validations include checks that the read communication complies with the approved format, for example mandatory fields are populated, Shipper exists as a Registered User, field lengths etc. Certain fields within the file are also validated against the data held by the GT, e.g. MPRN, meter serial number etc.
NDM Allocation	Determination of daily gas offtaken for NDM sites by using standard profiles & factors
Nominations Scaling Adjustment	Value applied daily to each Shipper for the daily imbalance of forecast gas inputs to ensure that total gas nominations match forecast total gas demand.
NTS Sites	Those sites directly connected to the National Transmission System.
Outgoing Shipper	Shipper who has lost or about to lose ownership of the Supply Point

michele.downes 23/9/13 10:40

Deleted: 0

Mike Berrisford 23/9/13 13:30

Deleted: 08/05/2013

Mike Berrisford 23/9/13 13:30

Deleted: 24/04/2013

Term / Acronym	Definition
Remotely read meters	These can be either 'Smart meters' or 'Advanced Meters' (AMR) which transmit digital reads.
Shipper Agreed Read	Transfer reading agreed by both the Outgoing and Incoming Shipper.

michele.downes 23/9/13 10:40  
**Deleted:** 0

Mike Berrisford 23/9/13 13:30  
**Deleted:** 08/05/2013

Mike Berrisford 23/9/13 13:30  
**Deleted:** 24/04/2013



## 9. Document Control

### Version History

Version	Status	Date	Author(s)	Summary of Changes
0.1	Initial Draft	20/04/2011	Xoserve	Merged content of the AMR Meter Reading Business Requirements document with the Interim Settlement Business Requirements document as agreed in the Settlement Workgroup on 13th April 2011.
0.2	Draft	04/05/2011	Xoserve	Updated as agreed in the PNUNC (AMR) Workgroup on 04/05/2011
0.3	Draft	24/05/2011	Xoserve	Updated as agreed in the PNUNC Workgroup (Settlement) on 24/05/2011
0.4	Draft	01/06/2011	Xoserve	Updated as agreed in the PNUNC Workgroup (Settlement) on 01/06/2011
0.5	Draft	05/07/2011	Xoserve	Updated as agreed in the PNUNC Workgroup (Settlement topic) on 05/07/2011
0.6	Draft	02/08/2011	Xoserve	Updated as agreed in the PNUNC Workgroup (Settlement) on 02/08/2011
0.7	For Workgroup Approval	22/08/11	Xoserve	Updated as agreed in the PNUNC Workgroup (Settlement) on 22/08/11
0.8	Published for review & comments	31/08/11	Xoserve	Published following review at workgroup
0.9	For workgroup review	23/09/11	Xoserve	Following workgroup review at 04/10/11 meeting to include comments received & agreed updates
0.10	Final tracked version	01/11/2011	Xoserve	Updates following agreement at the 01/11/2011 meeting.
1.0	Baselined	02/11/2011	Xoserve	Clean version of V0.10 for publication following PN UNC workgroup agreement on 01/11/2011.

michele.downes 23/9/13 10:40

**Deleted:** 0

Mike Berrisford 23/9/13 13:30

**Deleted:** 08/05/2013

Mike Berrisford 23/9/13 13:30

**Deleted:** 24/04/2013

1.1 1.2 1.3	Updated for approval	20/12/2011	Xoserve	1. Format amendments: bullets & headings amended for ease of loading into the requirements management tool (Pace). 2. Amendments following agreement at PN UNC.
1.4	Updated for approval	05/02/2013	Xoserve	Updates following changes agreed at PN UNC. This version approved & published as v2.0
2.0	Baselined	05/02/2013	Xoserve	10. Clean version of 1.4 following approval at PN UNC on 05/02/2013
2.1	Updated for Approval	08/03/2013	Xoserve	1. Updated following changes agreed at PN UNC
2.2	Updated for Approval	25/03/2013	Xoserve	2. Updated process maps replaced and updates made to section 5.10 (transfer reads agreed at PN UNC) & 8.15 (read performance)
3.0	Baselined	07/05/2013	Xoserve	ApApproved version of 2.2
<u>3.1</u>	<u>Updated for approval</u>	<u>20/09/2013</u>	<u>Xoserve</u>	<u>Updated following Mod 0453 discussions on 10/09/2013</u>

### Reviewers

Name	Version	Date
Workgroup attendees	All versions	See above
Industry (email issued via Joint Office)	V0.8	31/08/2011
PN UNC approved	V0.10	01/11/2011
PN UNC Approved	V1.3	05/02/2013

### Approval

Name	Role	Date
Settlement Workgroup		01/11/2011
PN UNC		01/11/2011

michele.downes 23/9/13 10:40
<b>Deleted:</b> 0
Mike Berrisford 23/9/13 13:30
<b>Deleted:</b> 08/05/2013
Mike Berrisford 23/9/13 13:30
<b>Deleted:</b> 24/04/2013