



respect > commitment > teamwork

# Draft Combined Settlement Processes

To-Be Process Maps v0.1



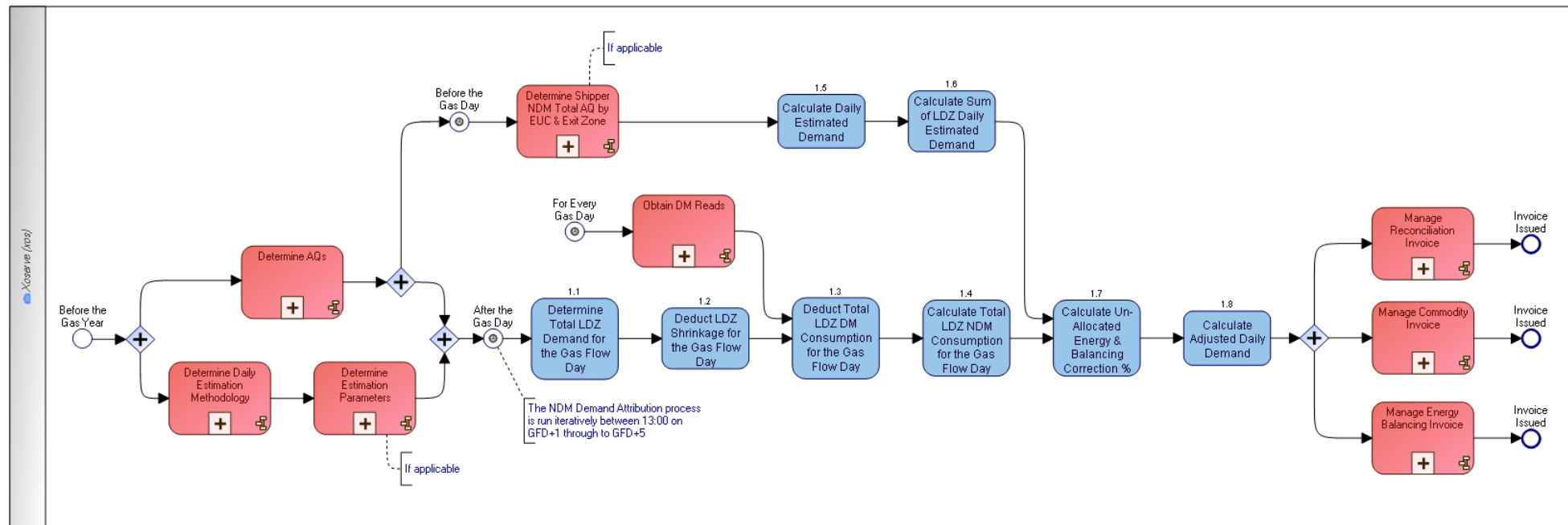

Version Control	
Owned by:	xserve (xos)
Version No:	0.2
Status:	Draft
Date updated:	31/03/2011
Updated by:	Michael Payley

Draft



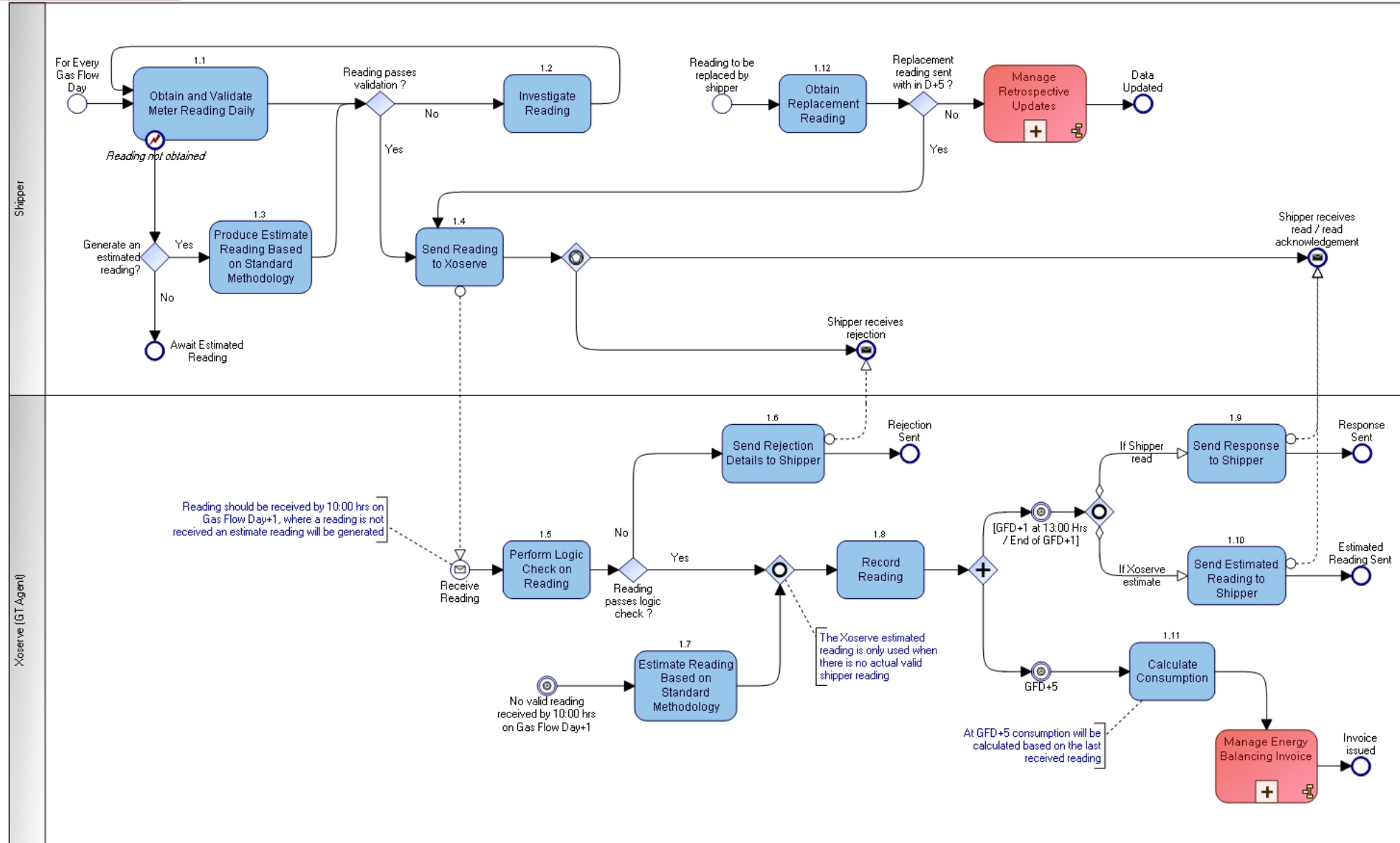

Version Control	
Owned by:	Xoserve (ros)
Version No:	0.1
Status:	Draft
Date updated:	12/05/2011
Updated by:	Michael Payley

Draft

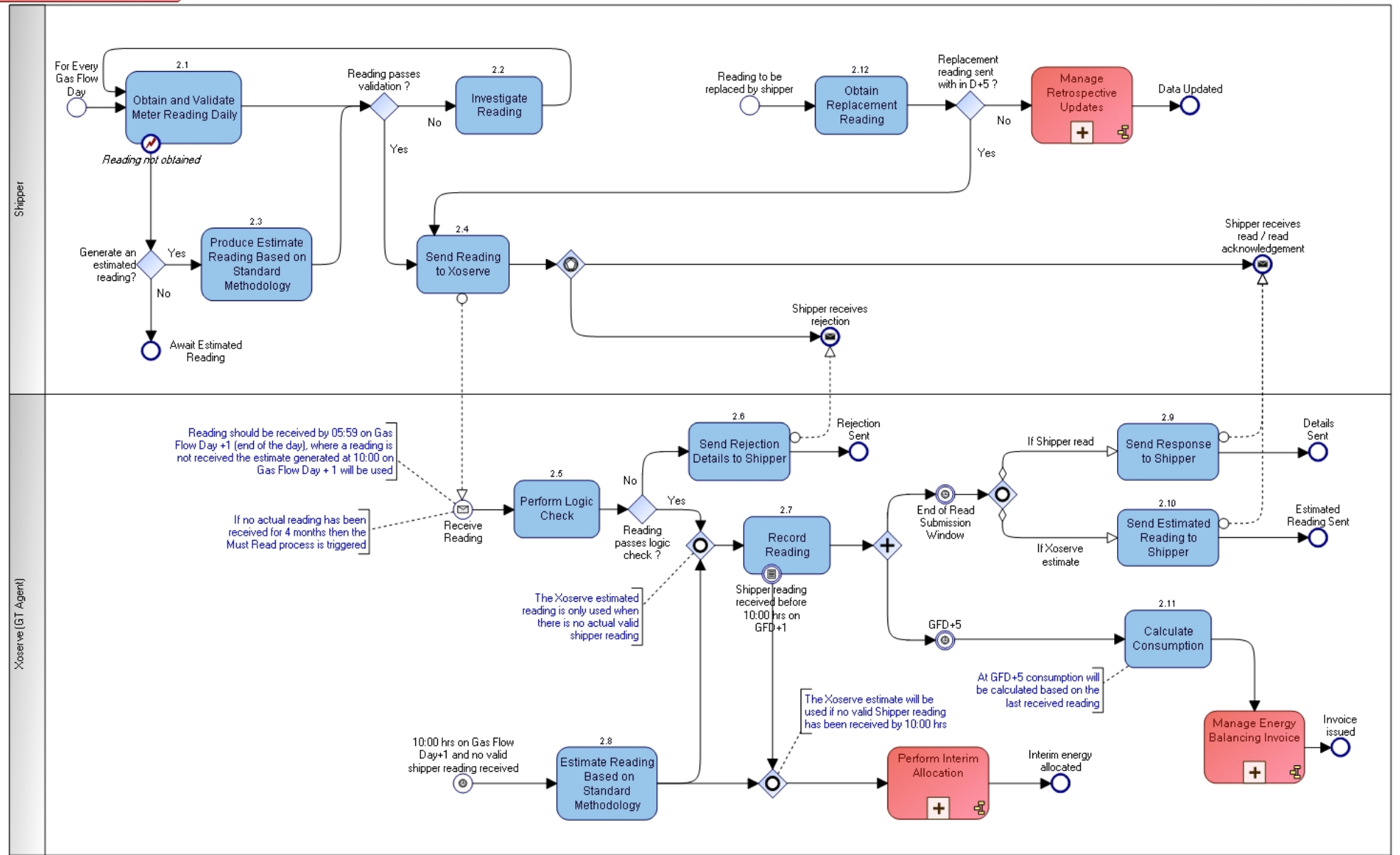

Version Control	
Owned by:	Xoserve (ios)
Version No:	0.1
Status:	Draft
Date updated:	12/05/2011
Updated by:	Michael Payley

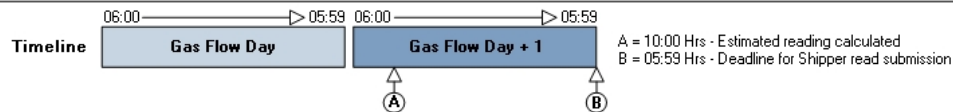

Draft

Manage Batched Daily Readings

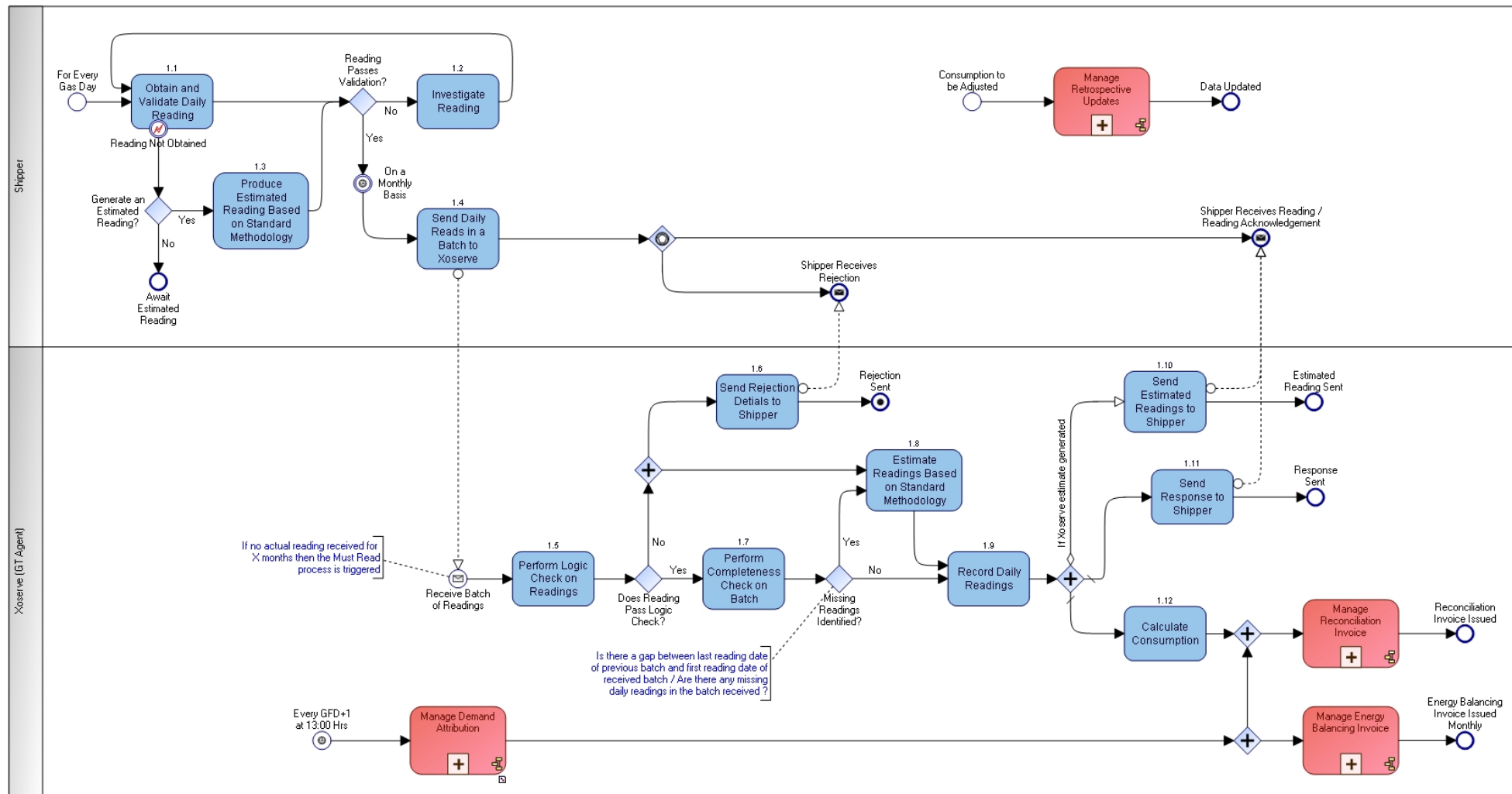

Version Control	
Owned by:	Xoserve (xos)
Version No:	0.1
Status:	Draft
Date updated:	12/05/2011
Updated by:	Michael Payley

Draft

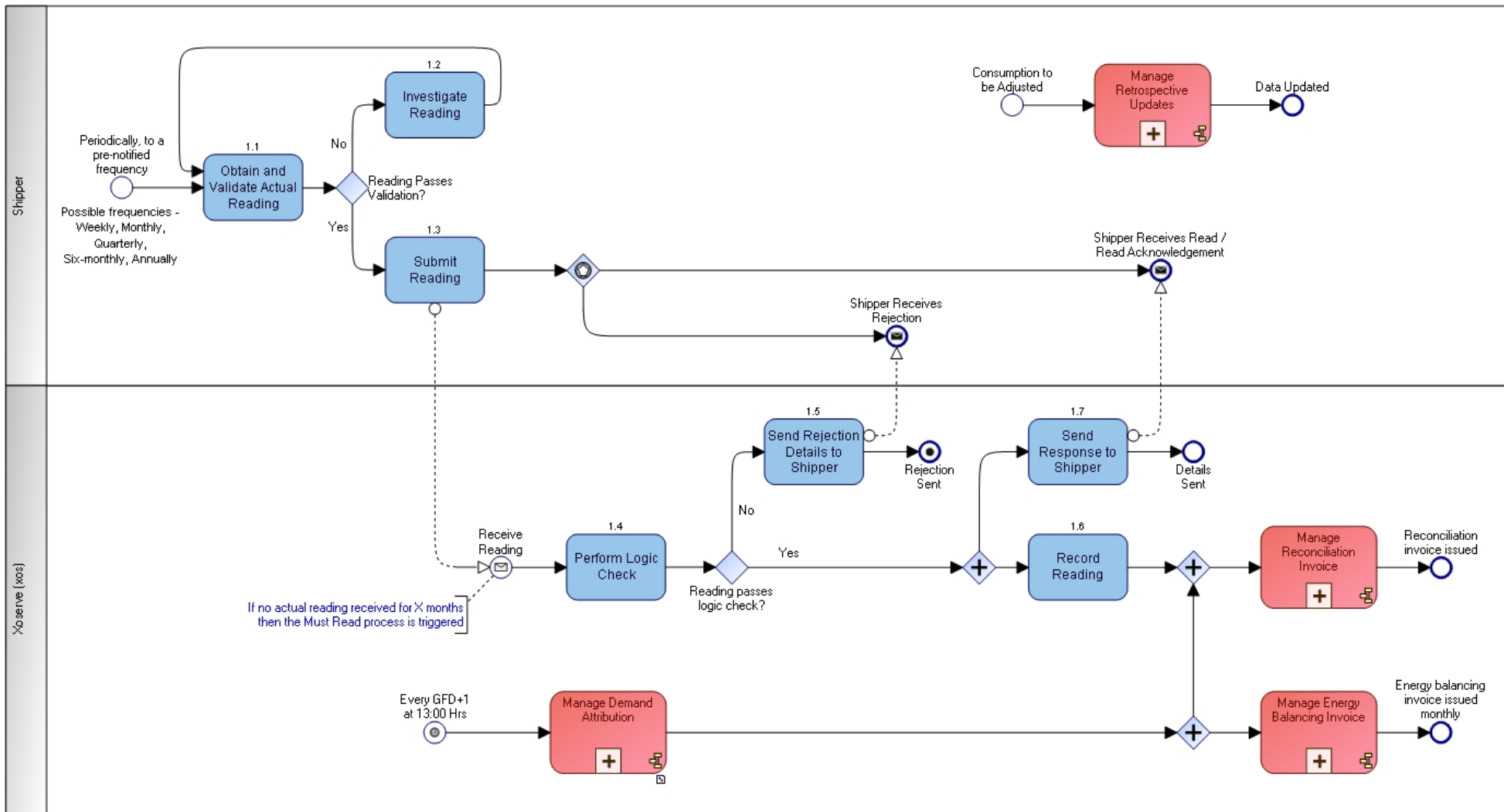

Version Control	
Owned by:	Xserve (xos)
Version No:	0.1
Status:	Draft
Date updated:	12/05/2011
Updated by:	Michael Payley

Draft



Manage Settlement Regime and Read Frequency

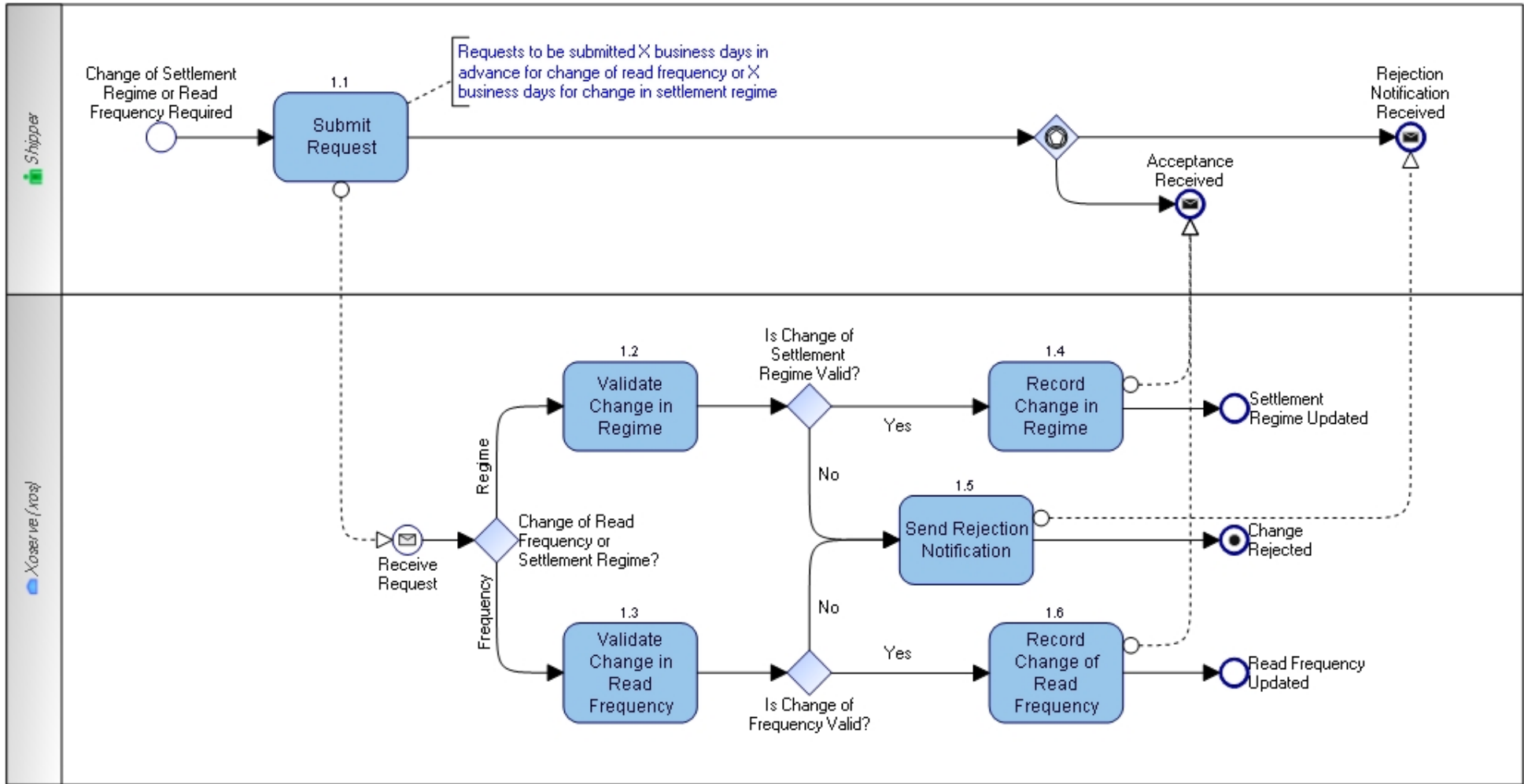

Version Control	
Owned by:	Xserve (xos)
Version No:	0.2
Status:	Draft
Date updated:	31/03/2011
Updated by:	Michael Payley

This process only covers a change to the settlement regime or read frequency where there is no change in Shipper

Draft