



respect > commitment > teamwork

# Billing & Invoicing End to End Process Walkthrough

25<sup>th</sup> November

# Call-outs

An information only call out.

Denotes a change in the process.

A BRD reference.

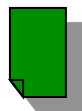

File Changes – No change



File Changes - Minor



File Changes - Medium



File Changes – Major

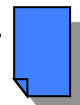

File Changes - New

xserve



respect > commitment > teamwork

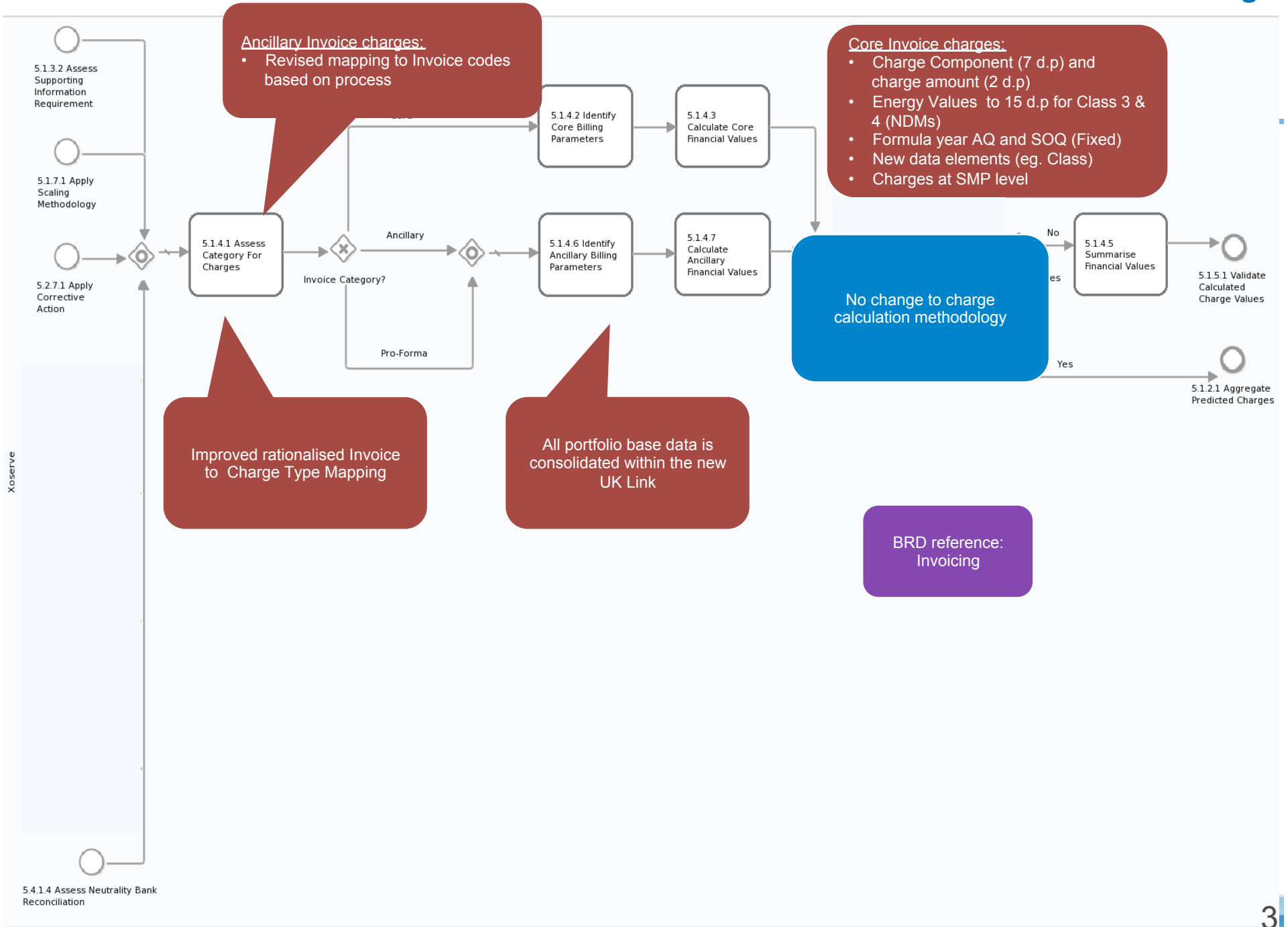

# Perform Reconciliation Scaling Adjustment

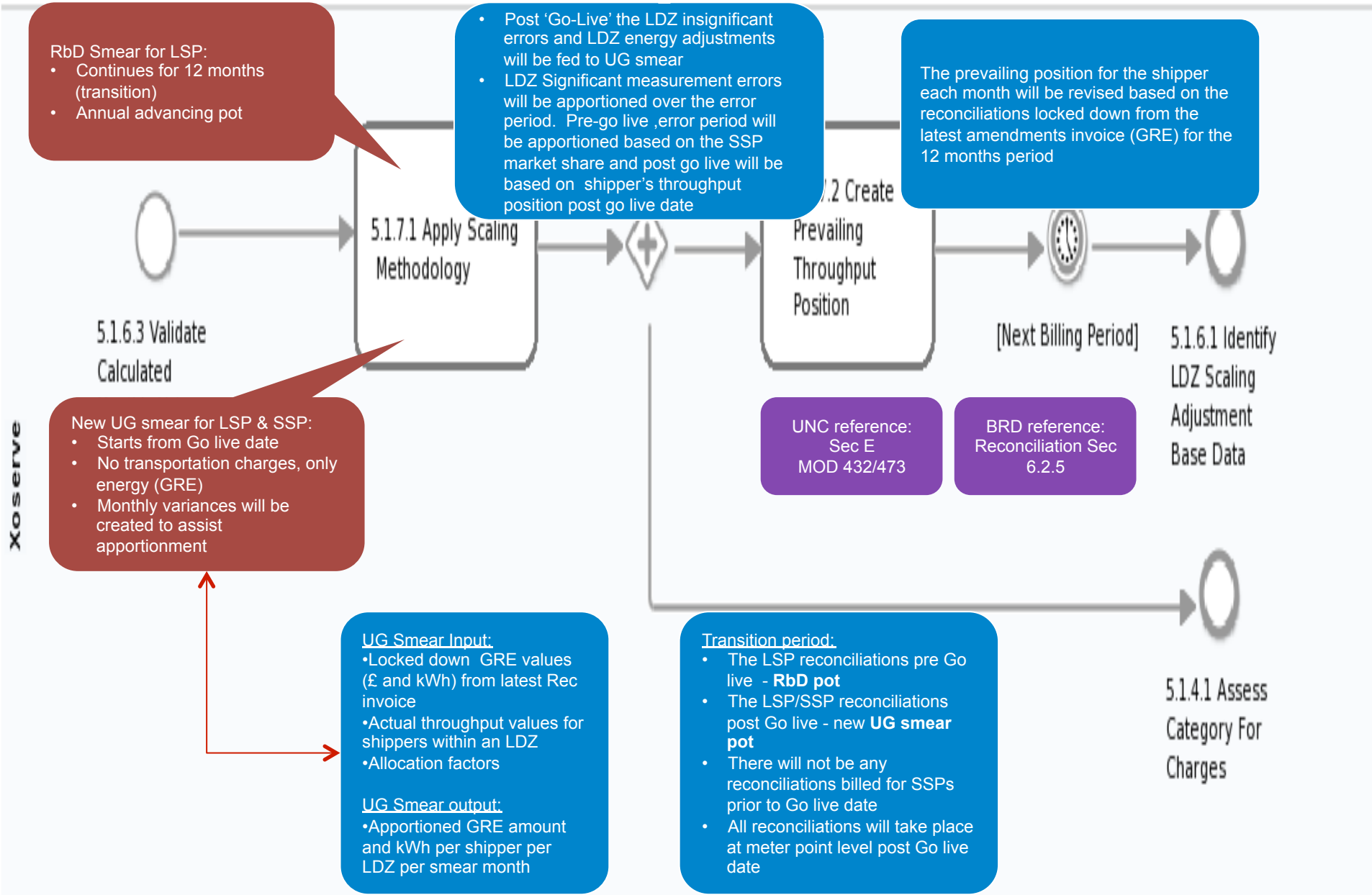

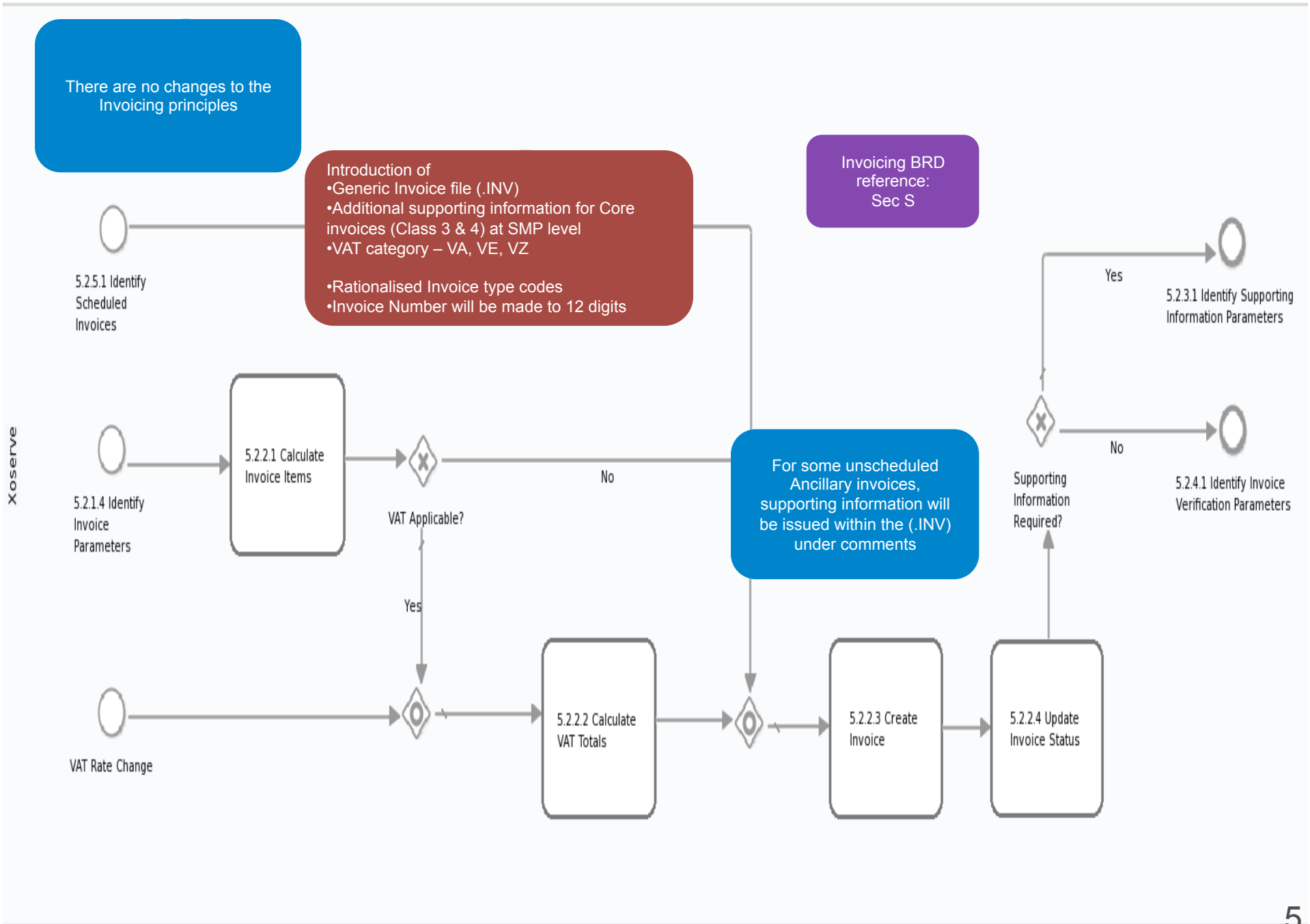

## 5.2.5 Issue Invoices

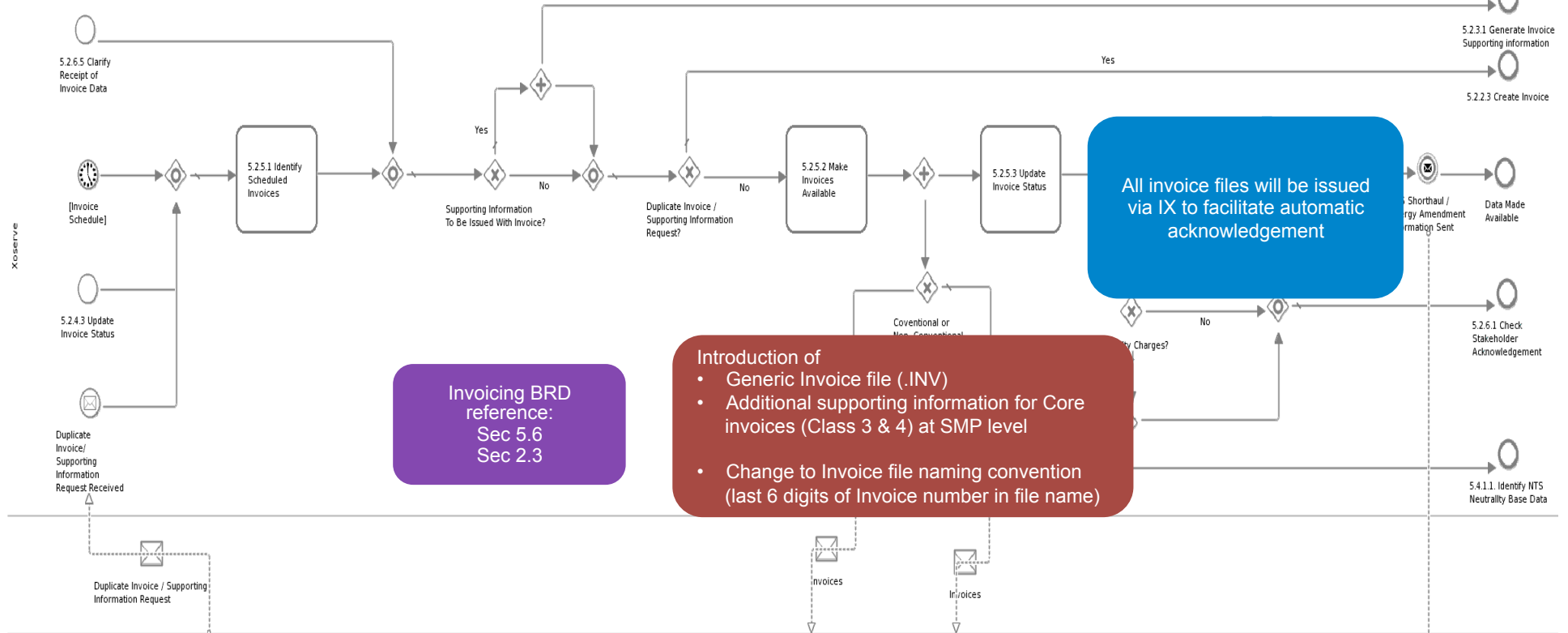

Invoicing BRD reference:  
Sec 5.6  
Sec 2.3

Introduction of

- Generic Invoice file (.INV)
- Additional supporting information for Core invoices (Class 3 & 4) at SMP level
- Change to Invoice file naming convention (last 6 digits of Invoice number in file name)

All invoice files will be issued via IX to facilitate automatic acknowledgement

Generic Invoice file

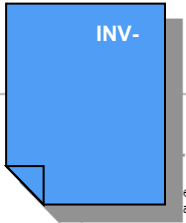

Stakeholder

National Grid Transmission



**File Changes – No change**



**File Changes - Minor**



**File Changes - Medium**

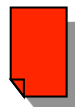

**File Changes – Major**

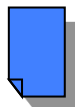

**File Changes - New**

# Generate Invoice Supporting Information

